

LEGO

MARS MISSION

7646



1

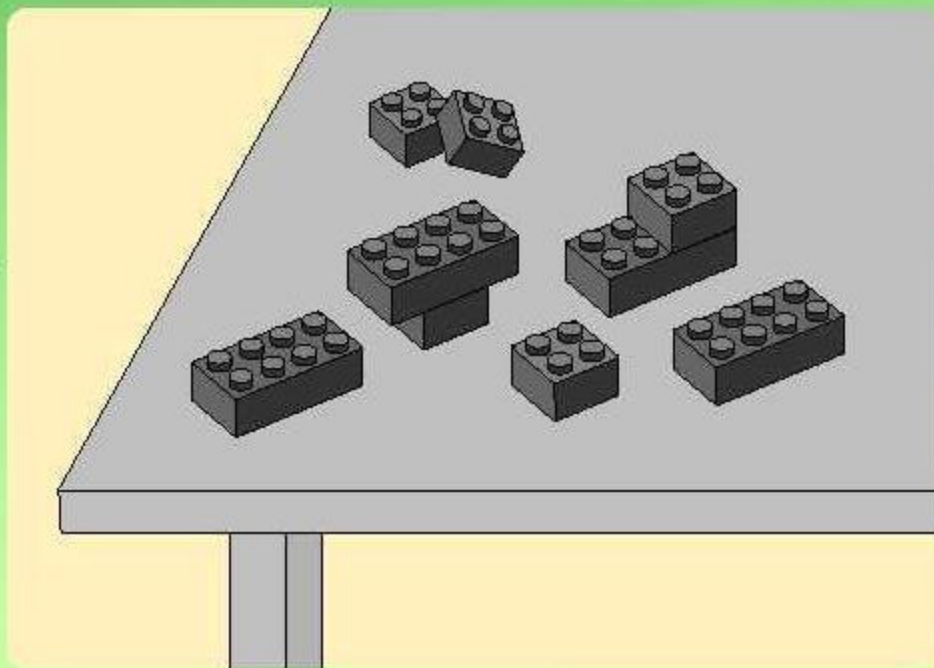
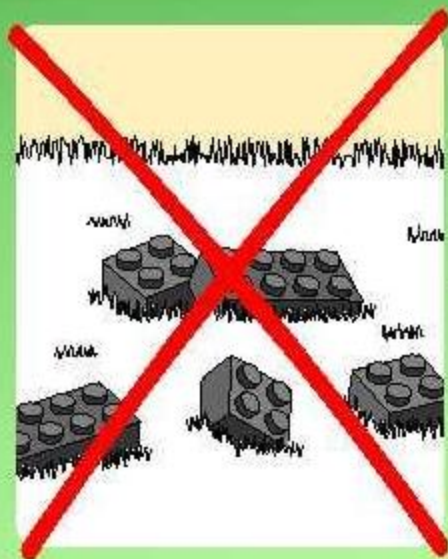

2



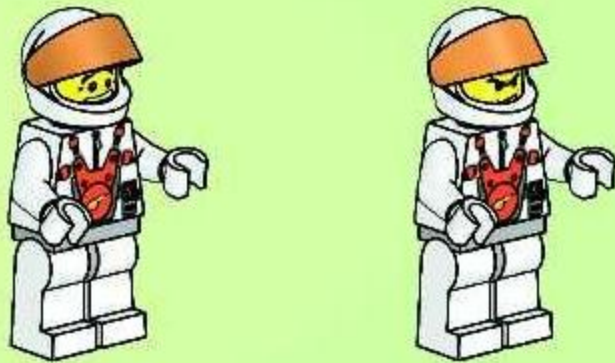
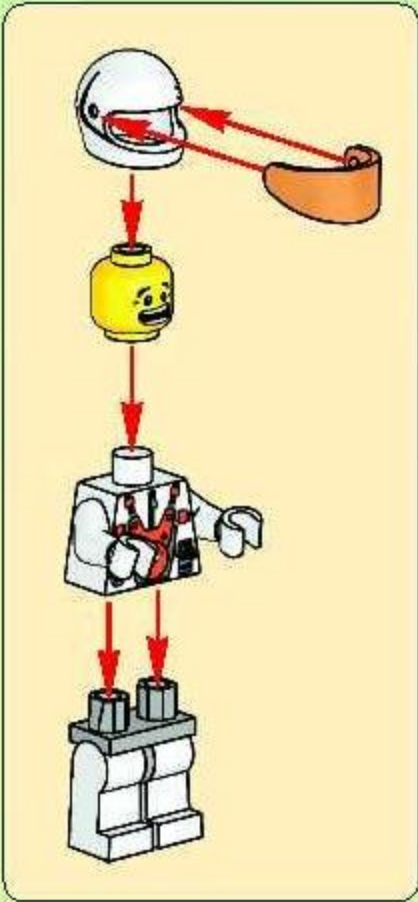
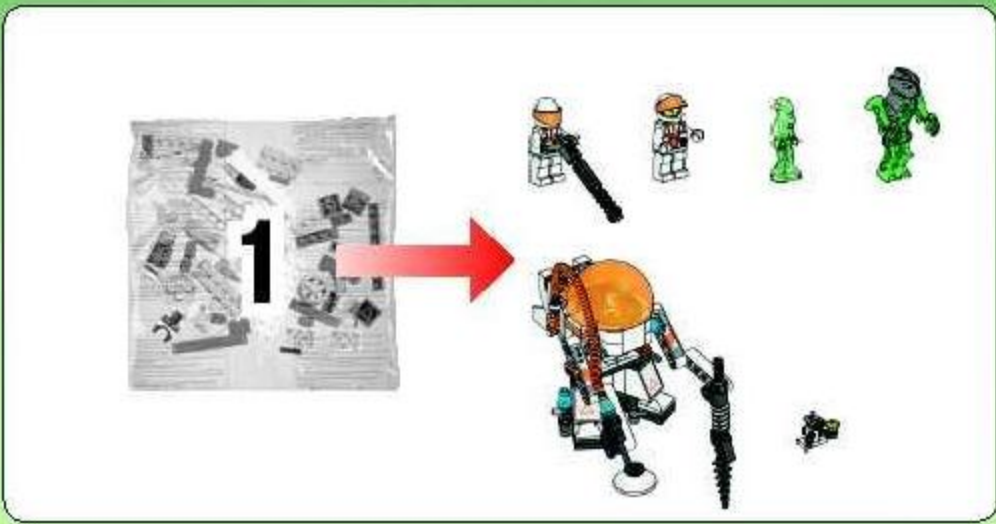

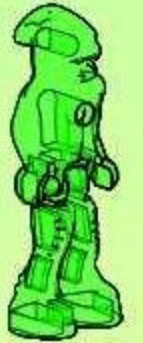
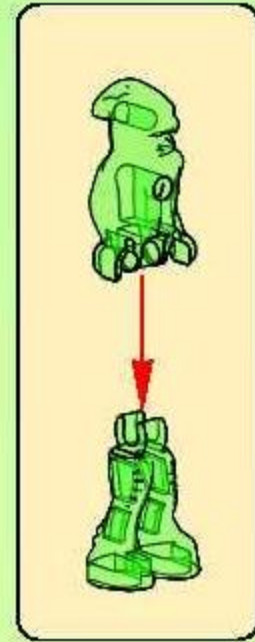
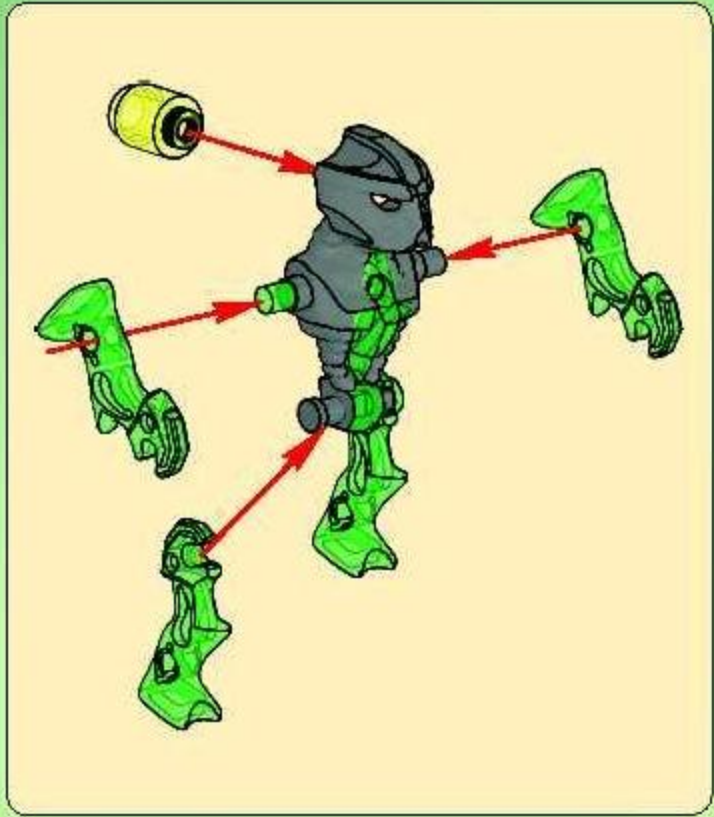

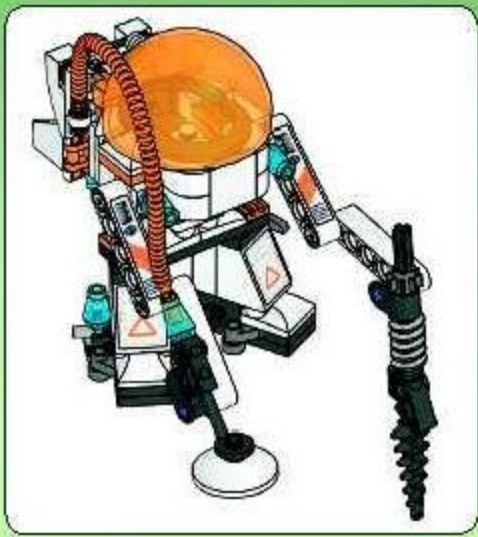

1



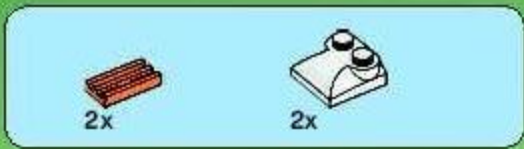

2



3

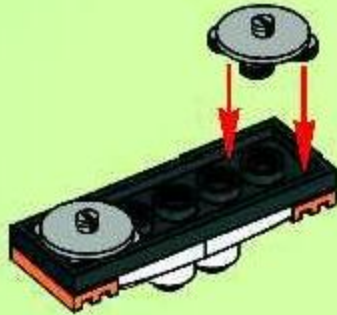



1



2

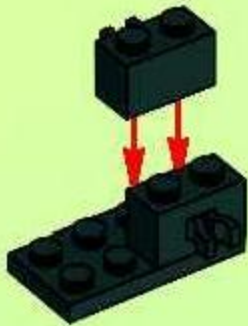

3

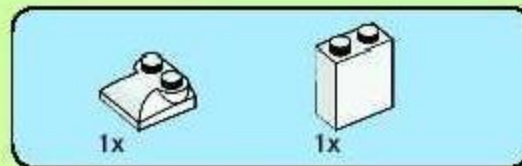

4

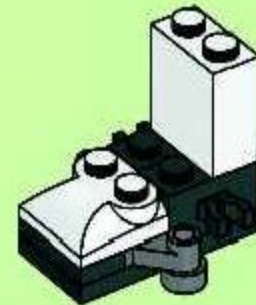

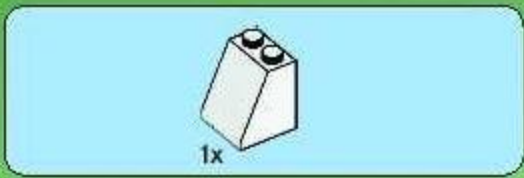

5



6



2x

4

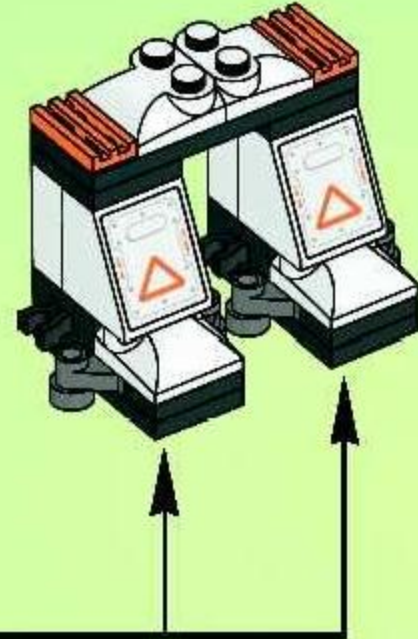



5

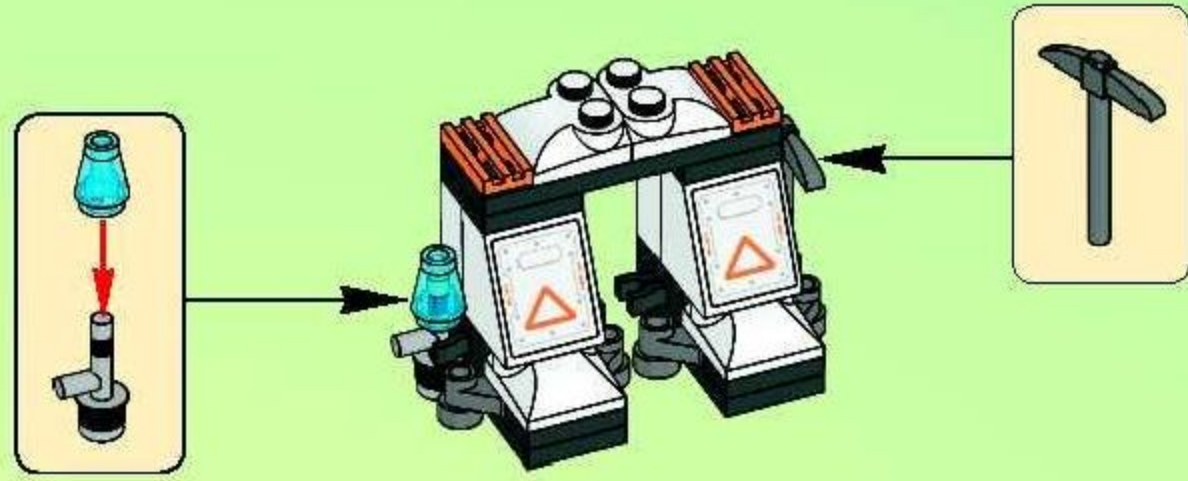



1x

6



2x

7





1

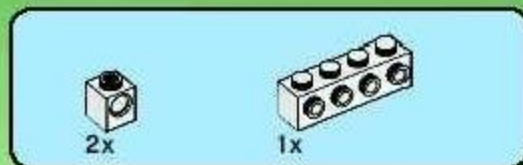

2

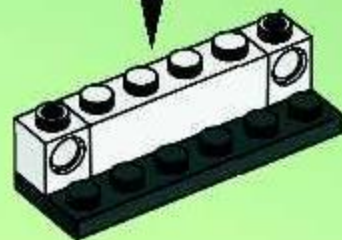
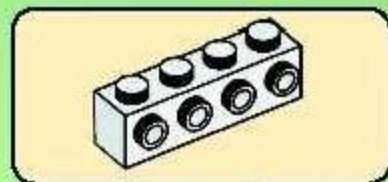

3

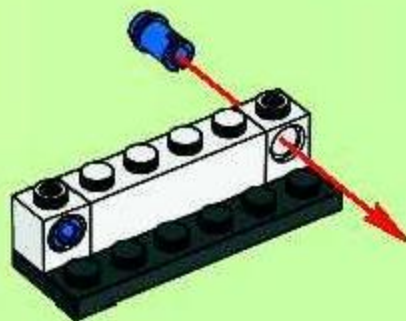

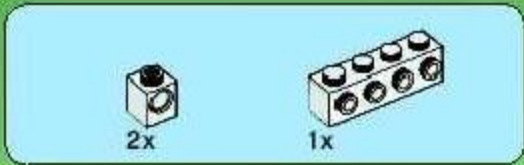

4

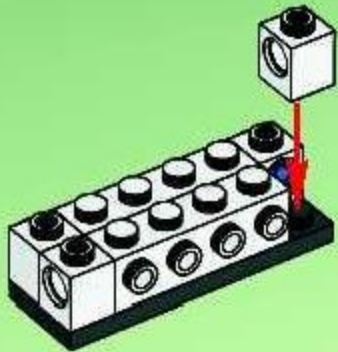

5

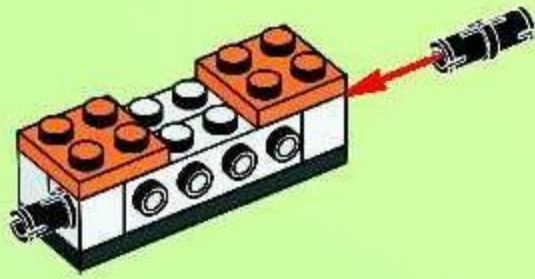



6

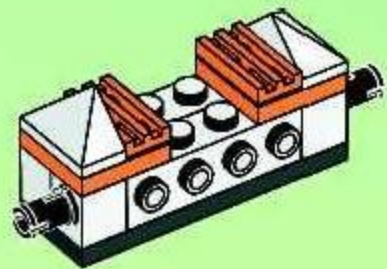

7

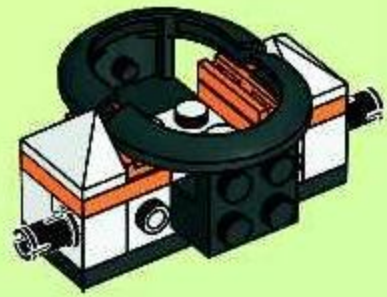

8

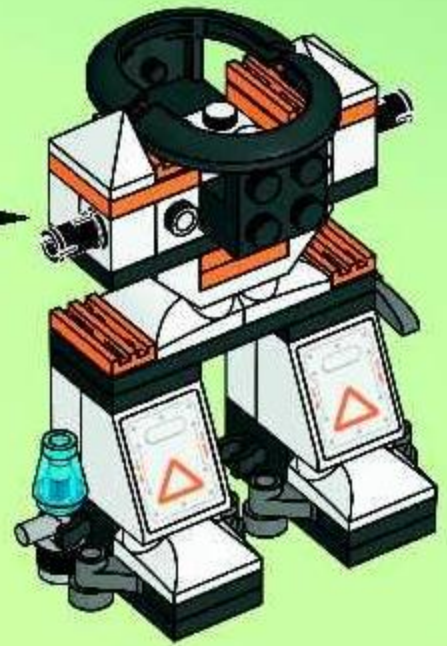

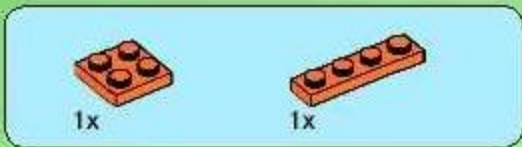
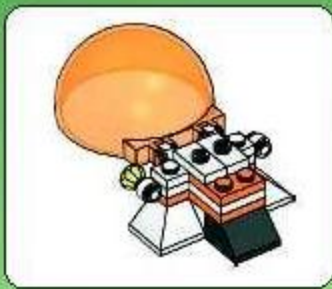

1

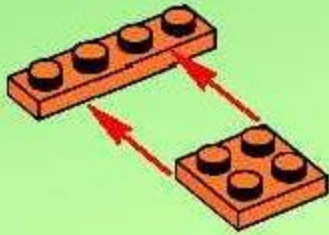

2

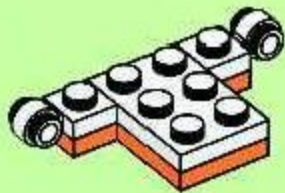

3

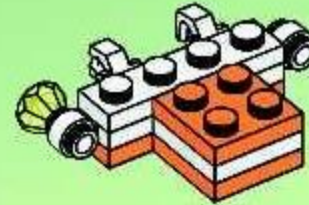

4

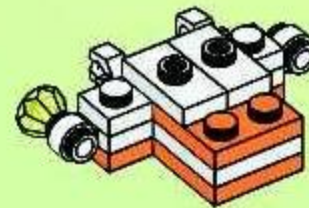

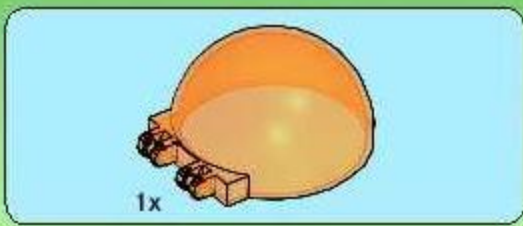

5

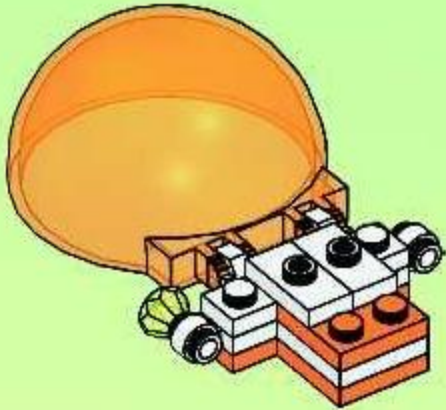

6





1x

7

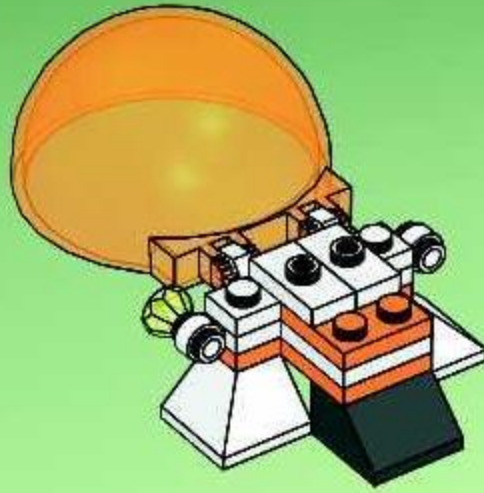

9

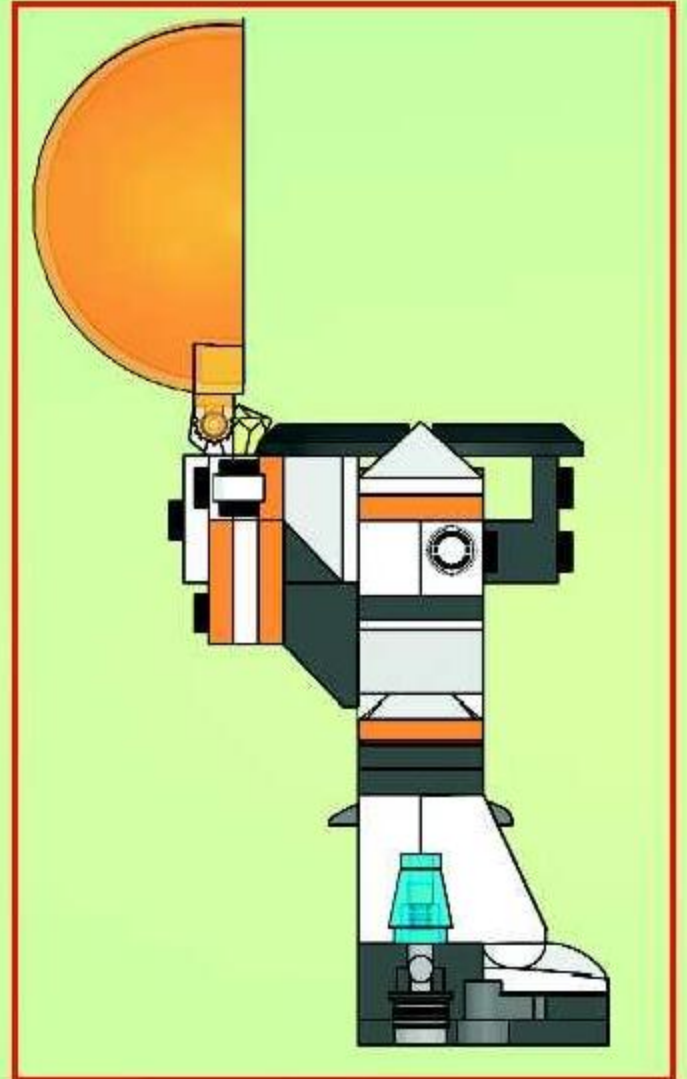
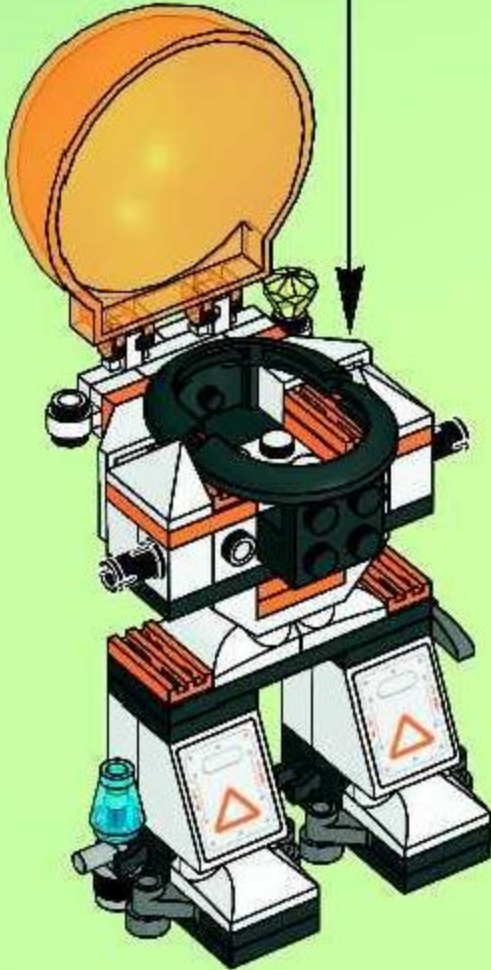



10

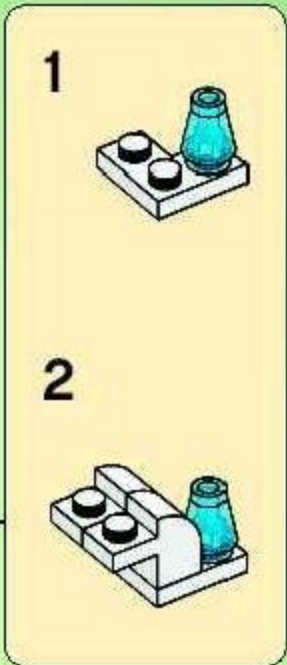
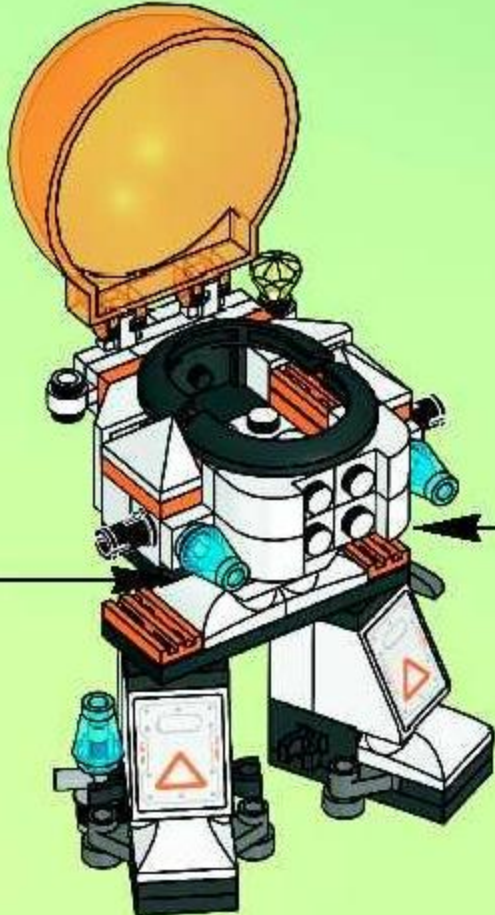
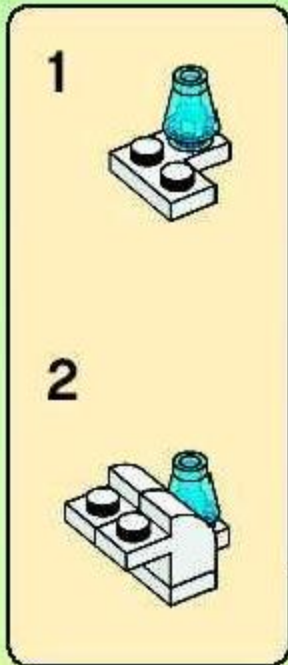



1x

11

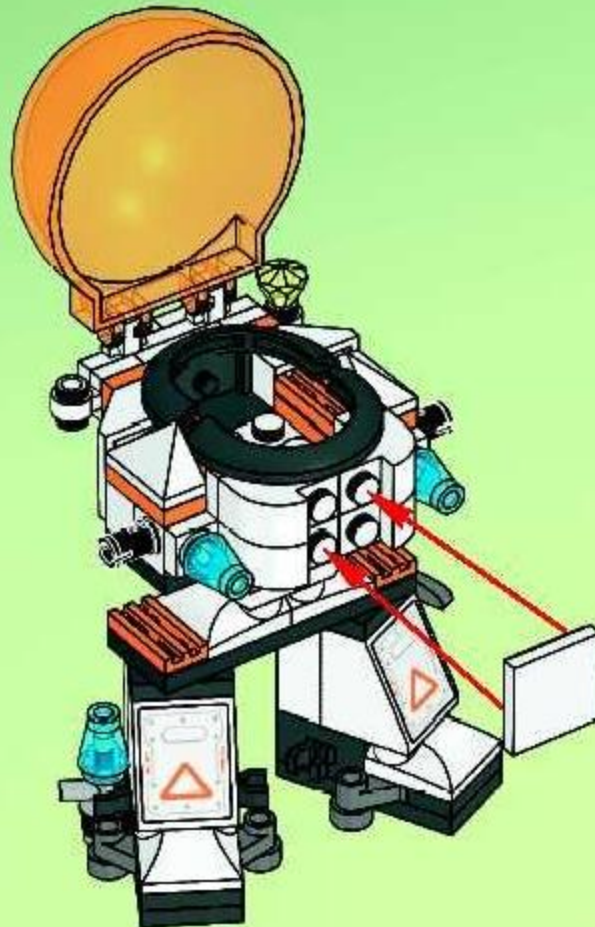



12

1

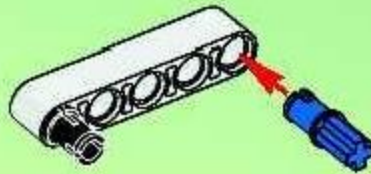

2

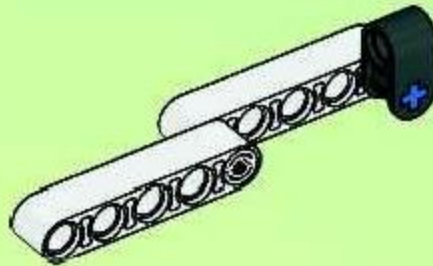

3

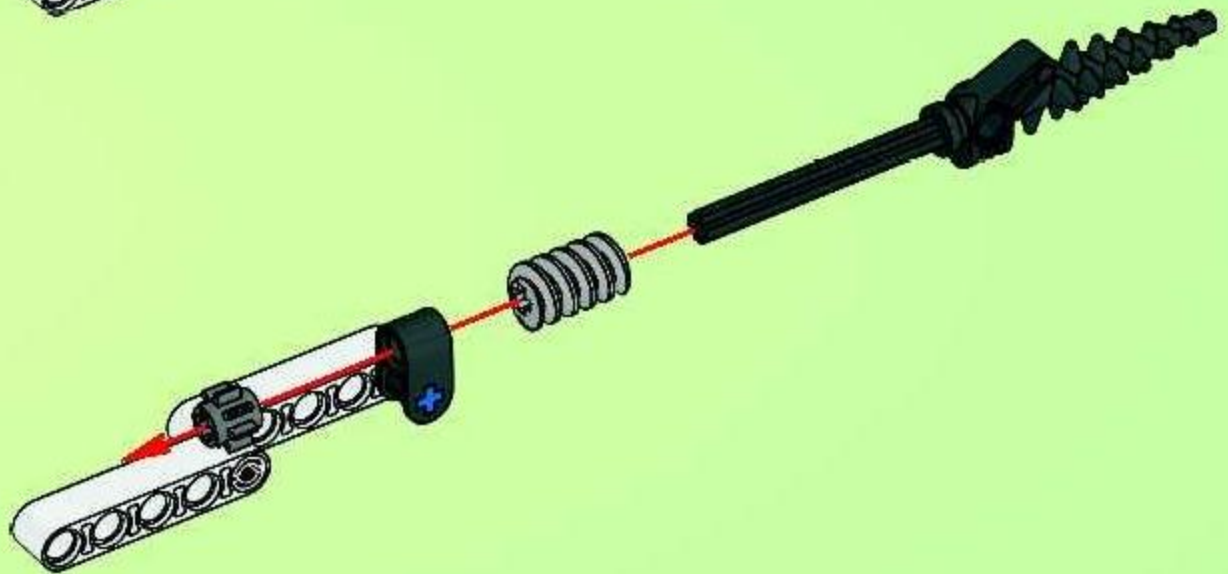

4

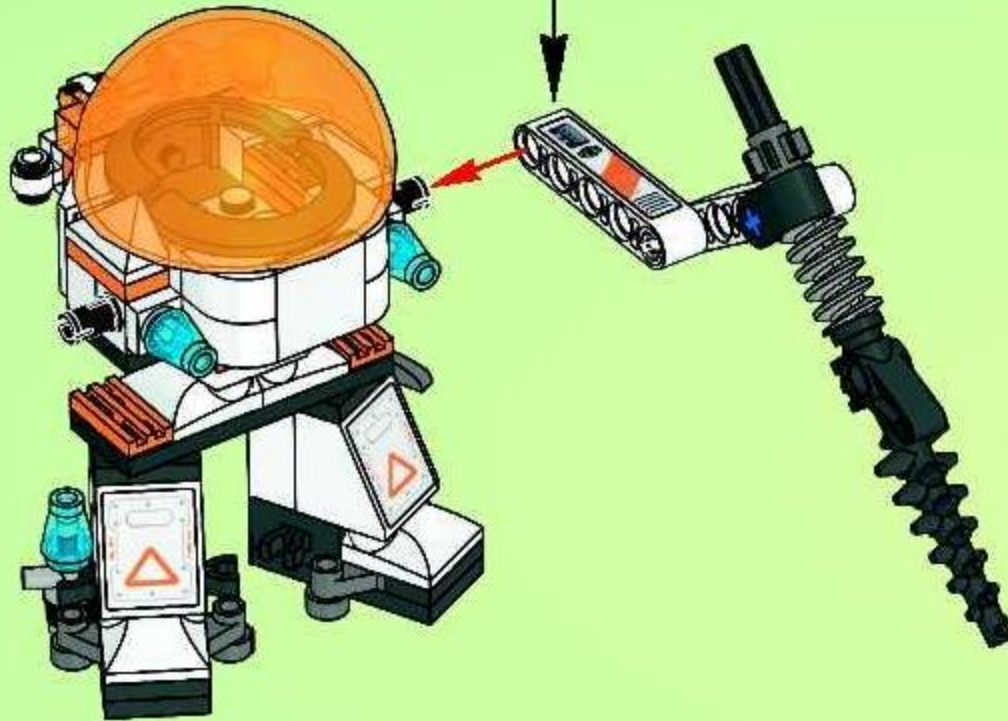
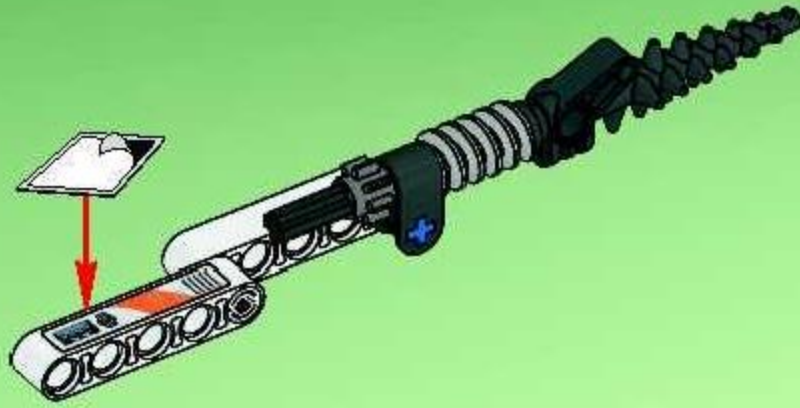



13

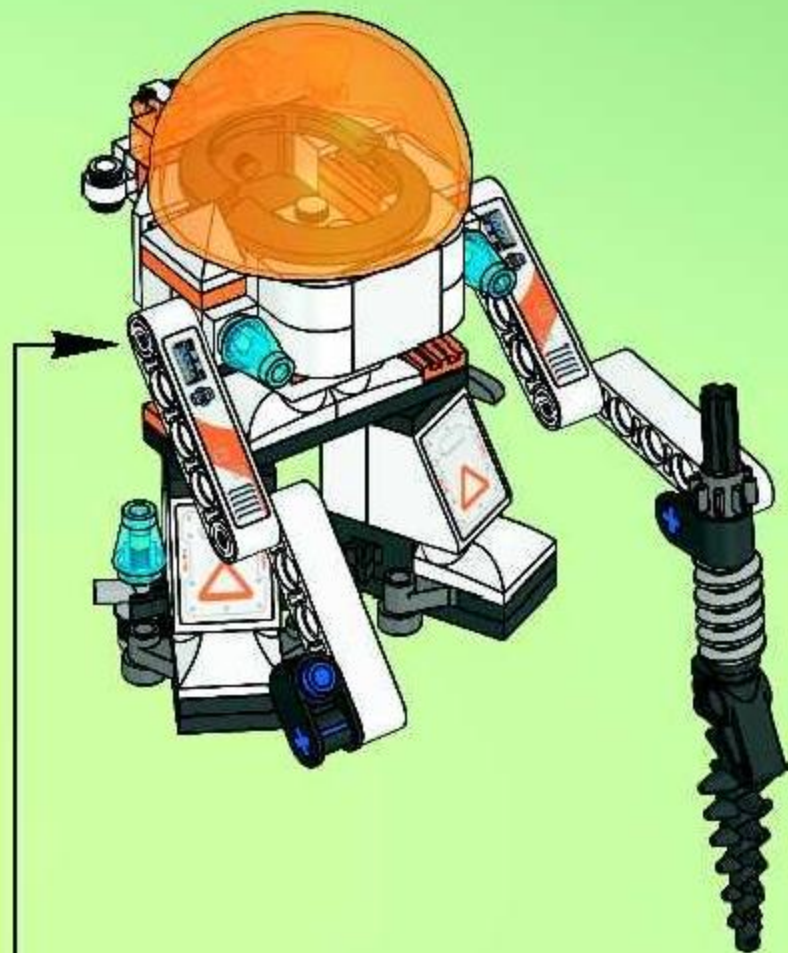
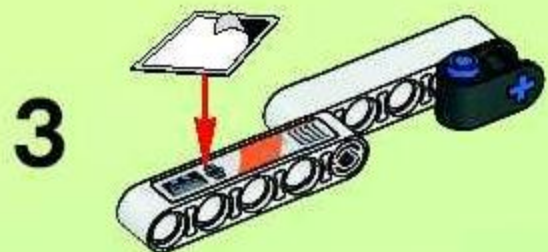
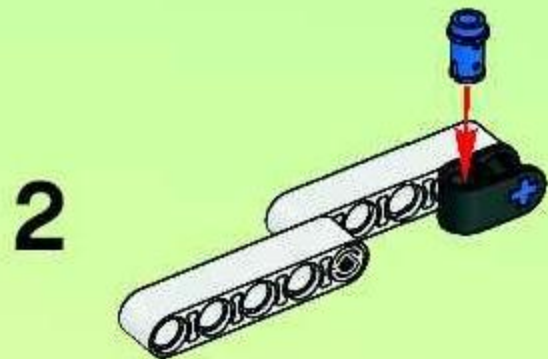
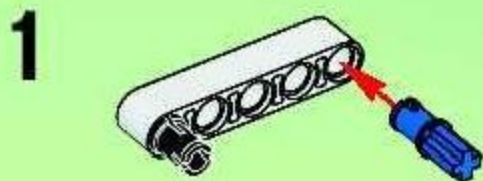

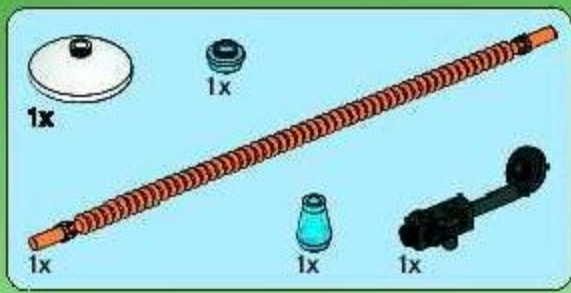

14

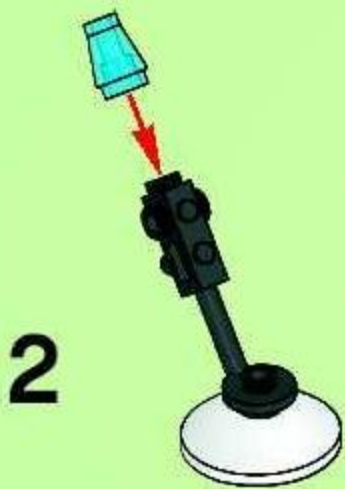
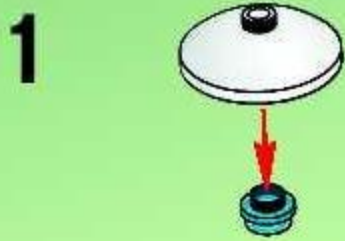

3



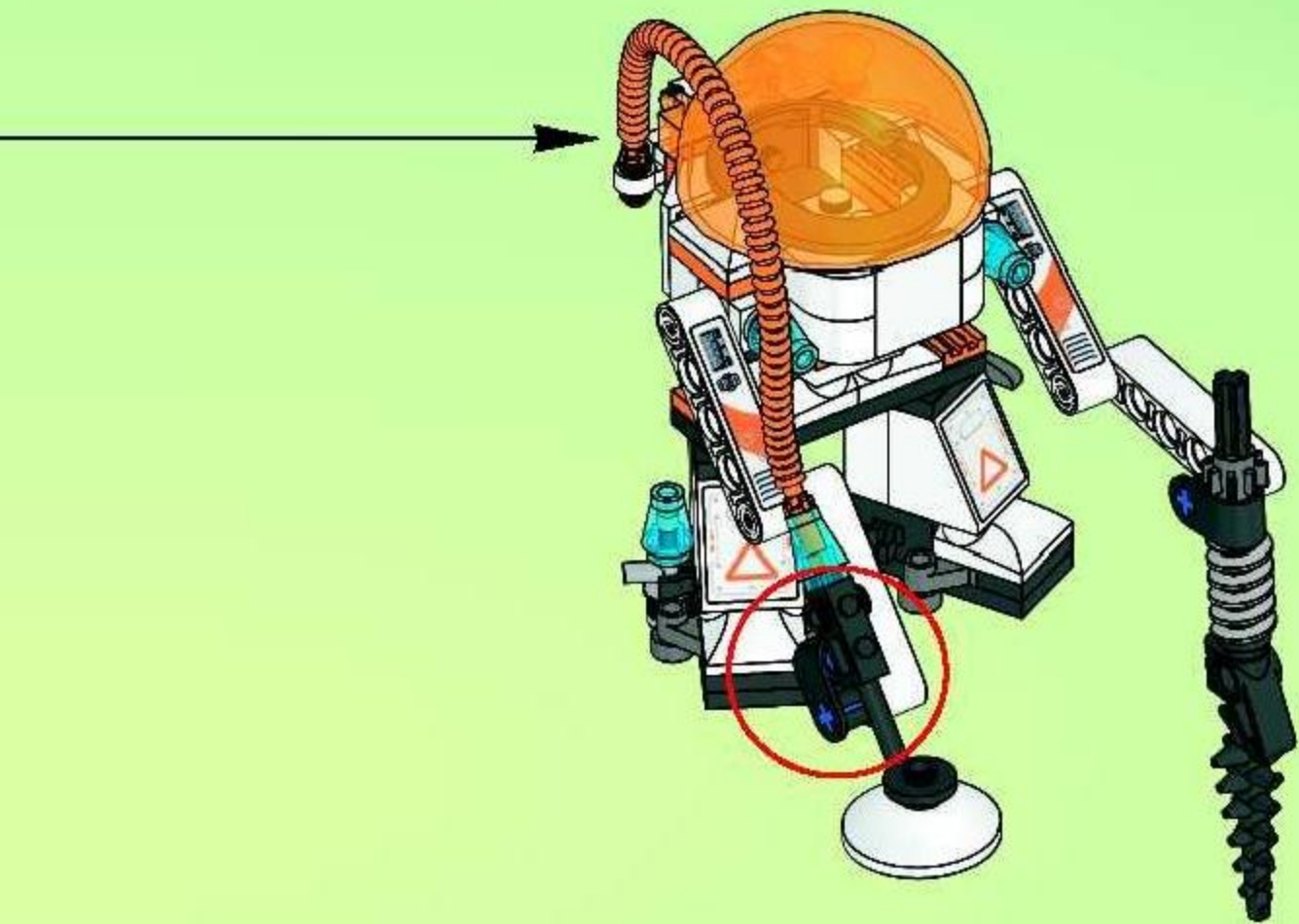

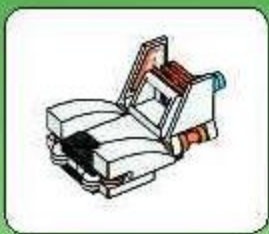

1



2

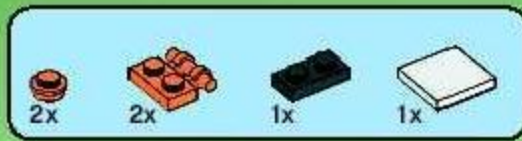
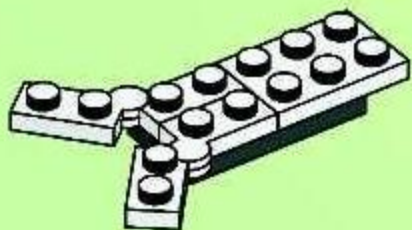

3

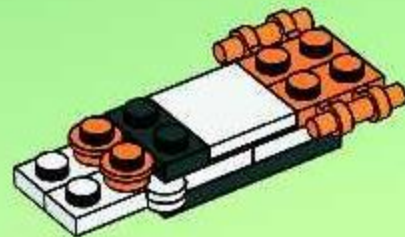

4

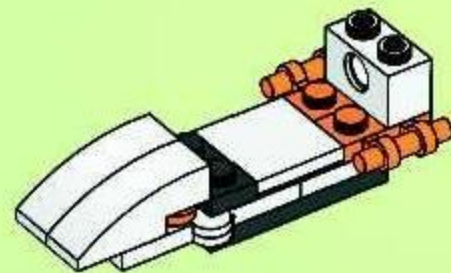



5

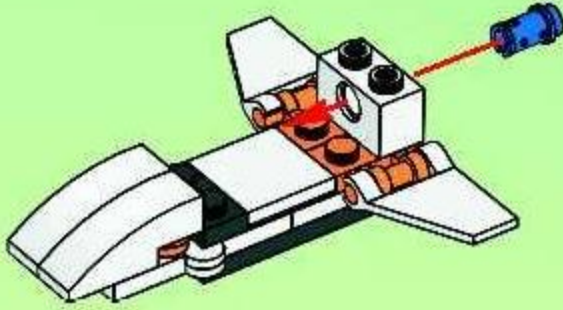

7

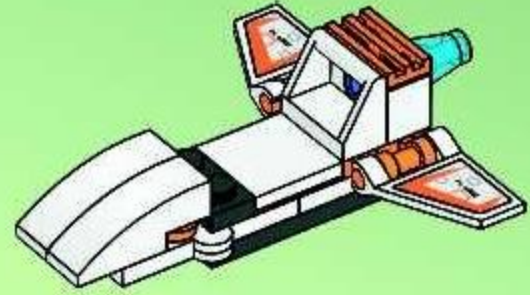

6

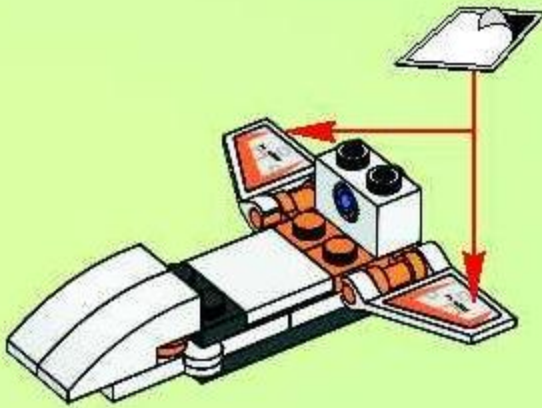

8

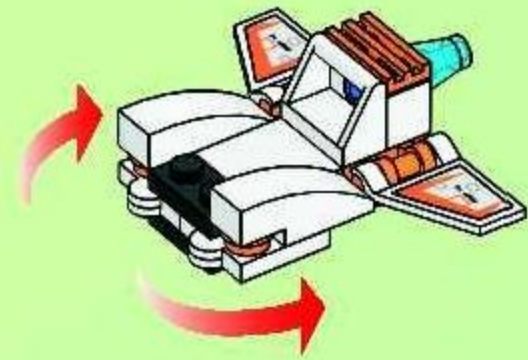

9



15

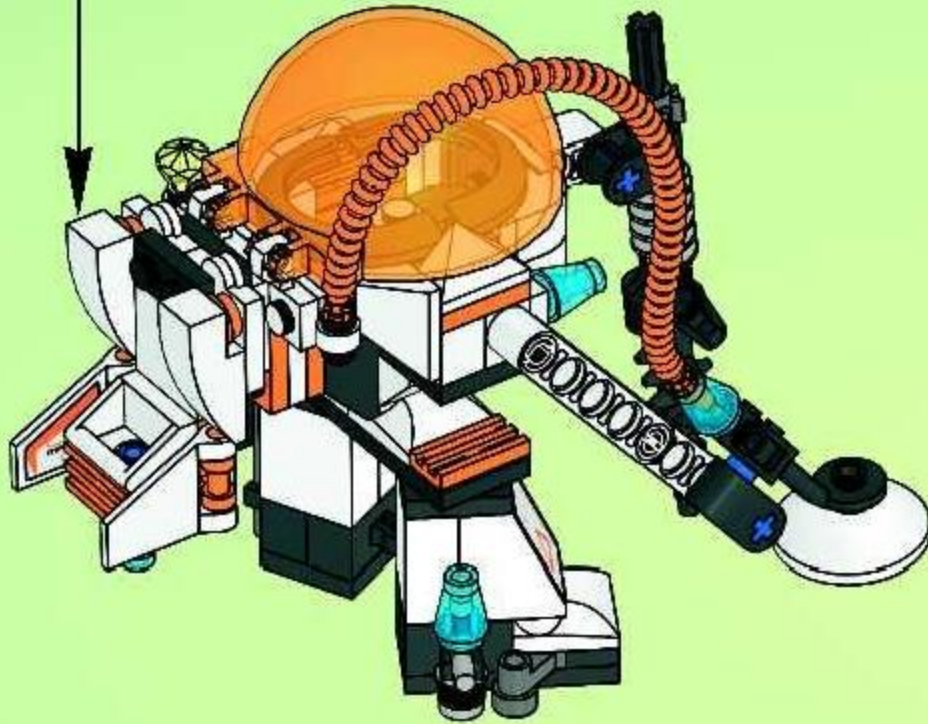



16

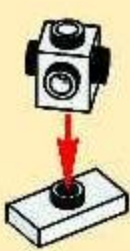

1

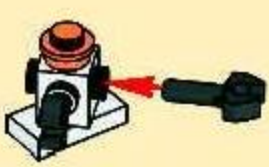

2

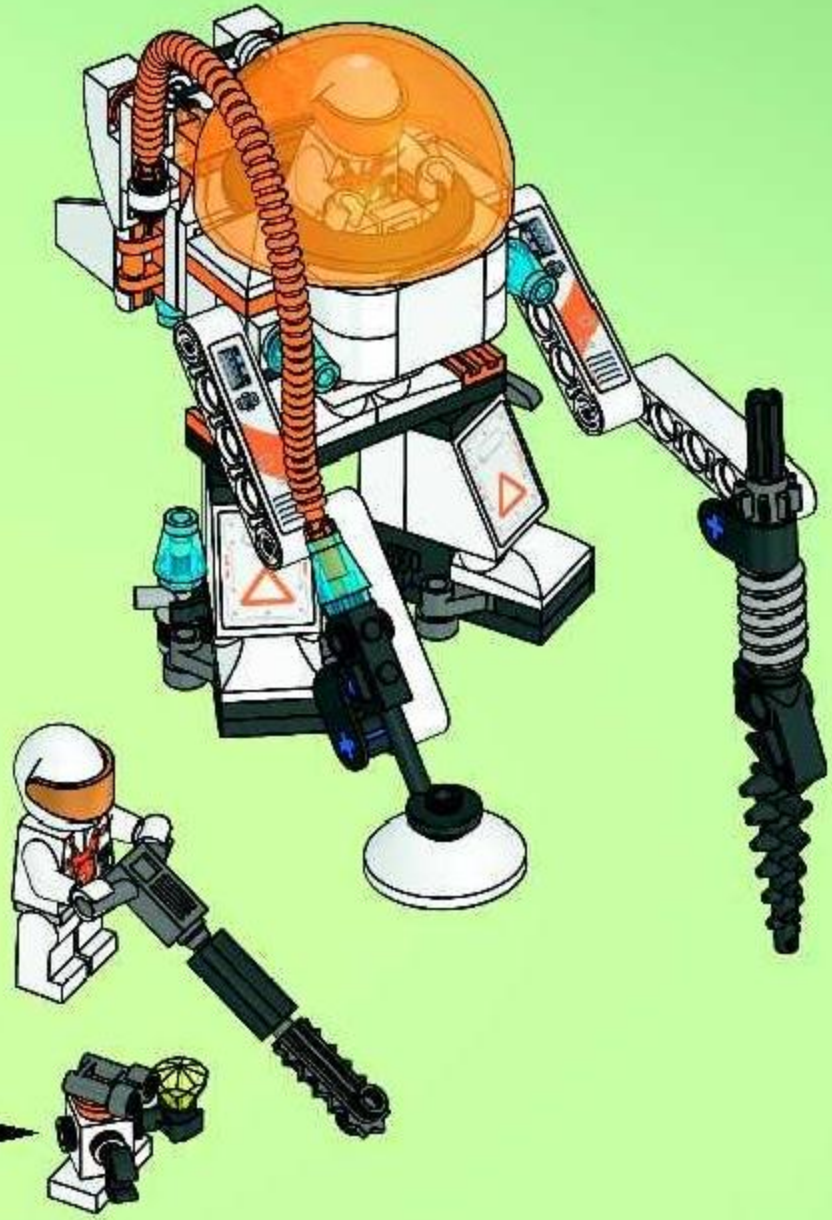

3



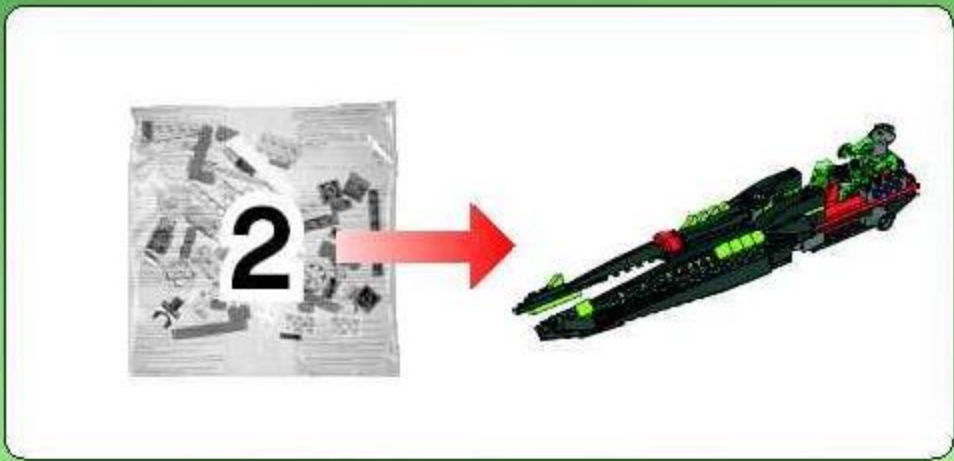

1





2

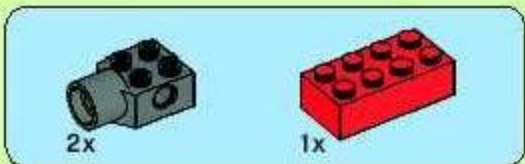
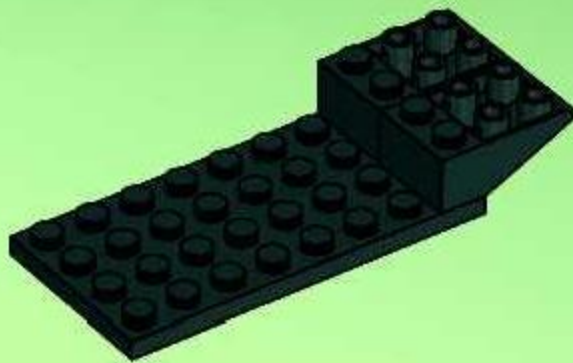

3

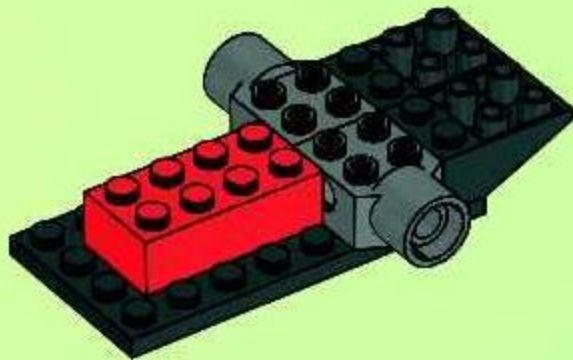



4

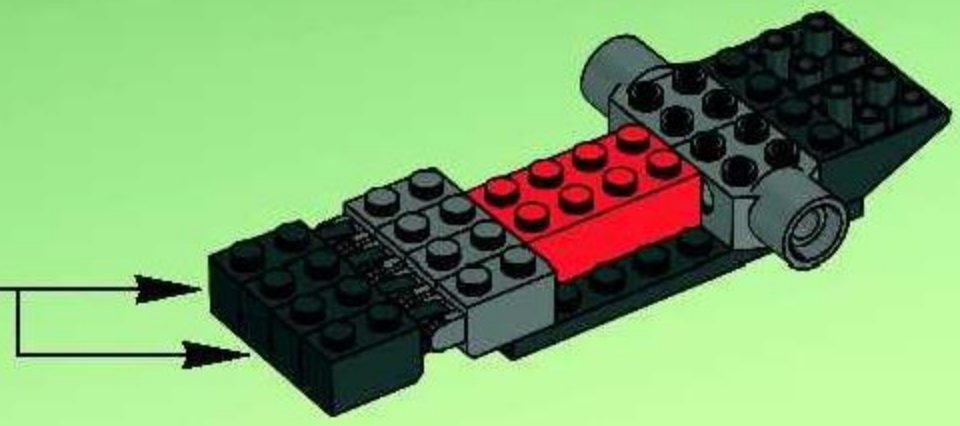
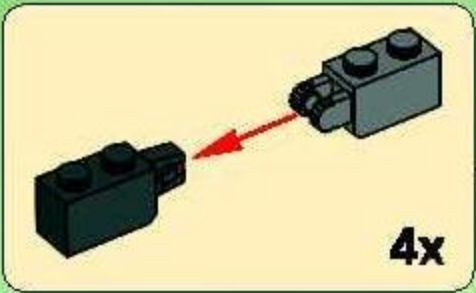

5

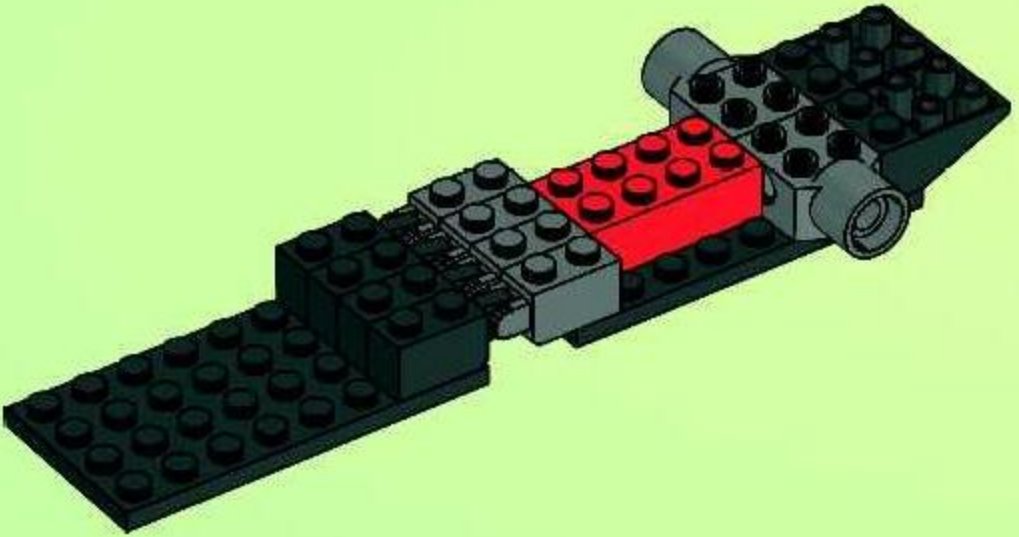

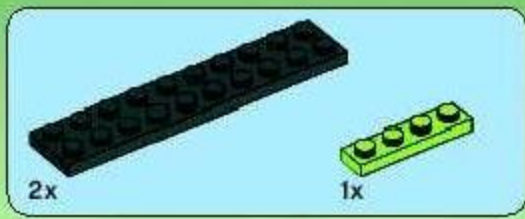

6

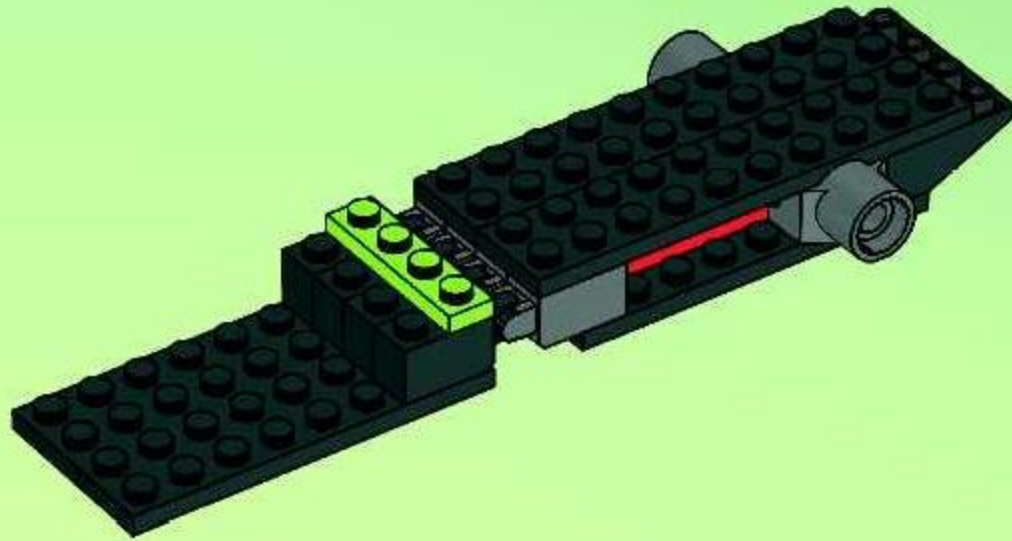



7

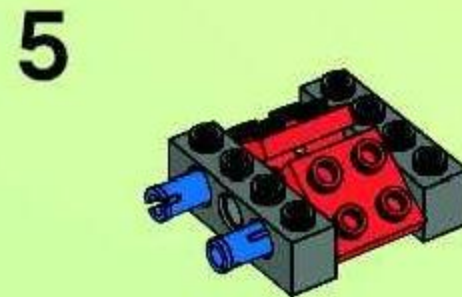
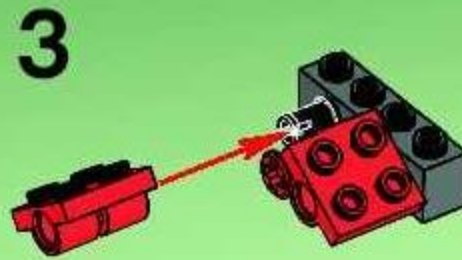
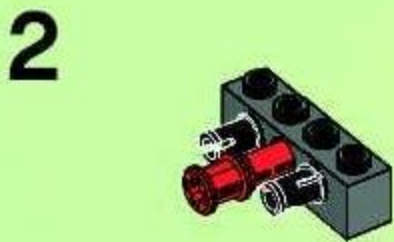
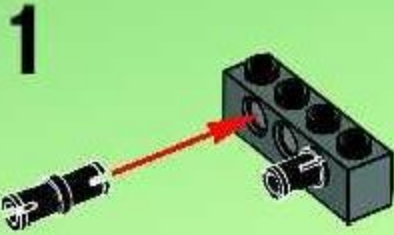

6

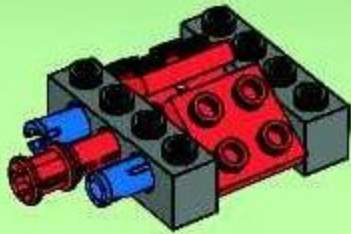

7

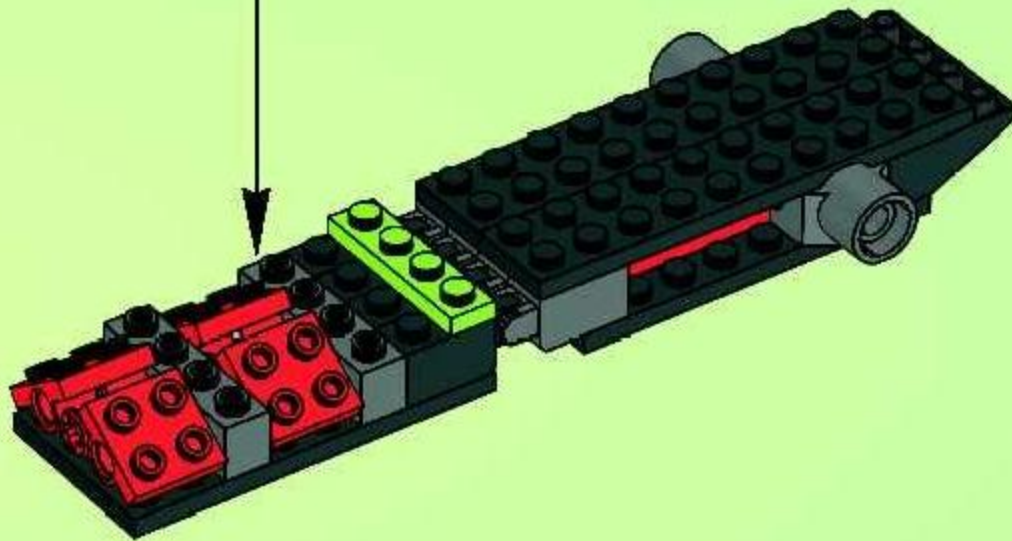
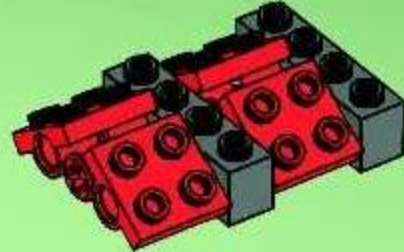

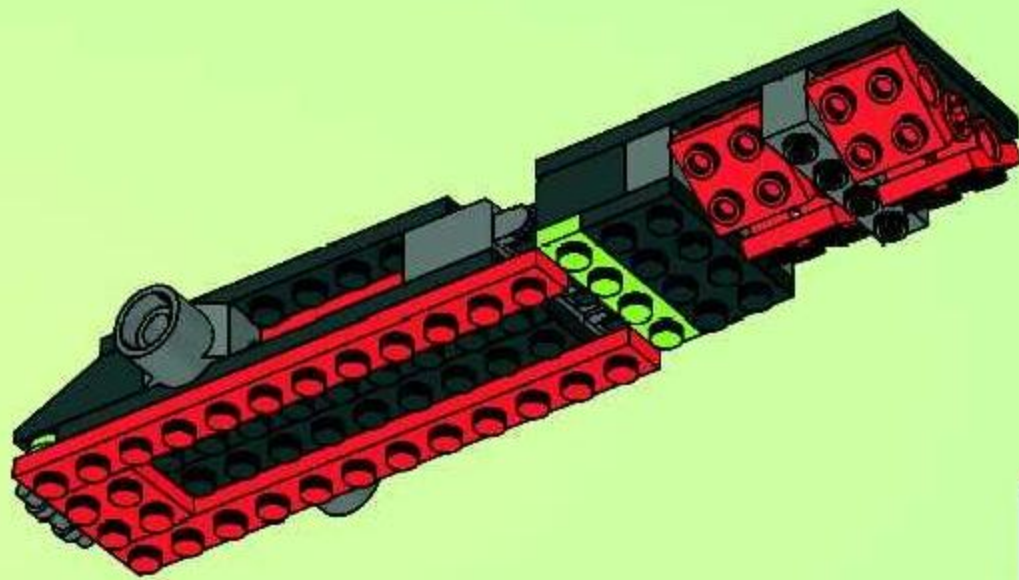

6

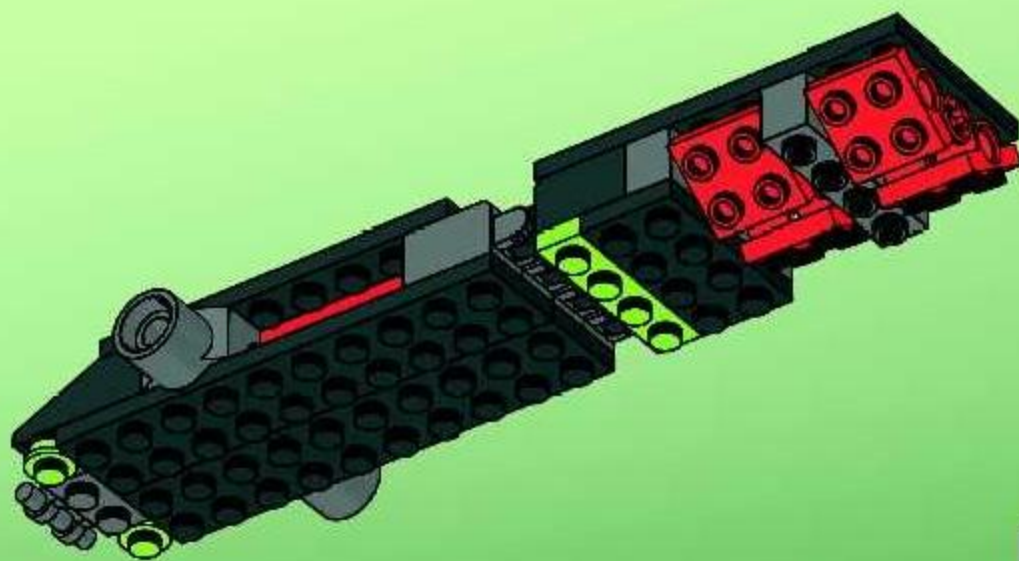
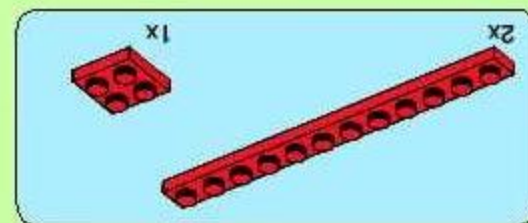

8





10

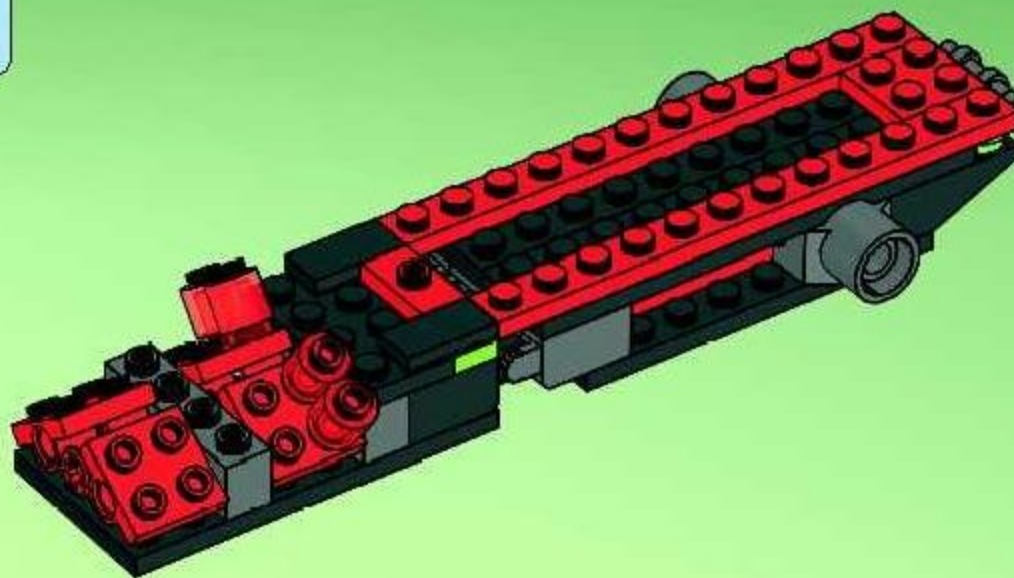

11

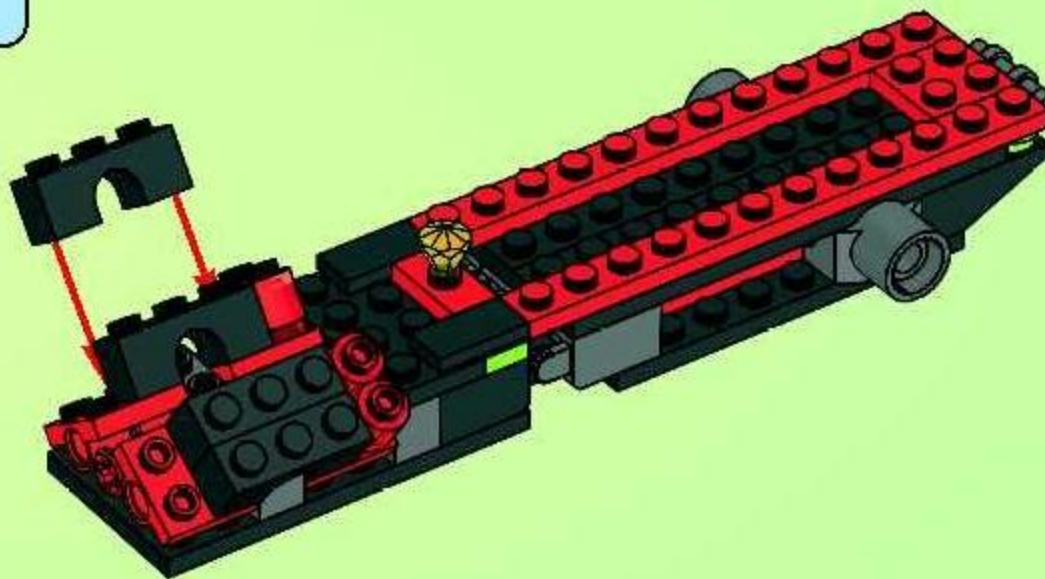

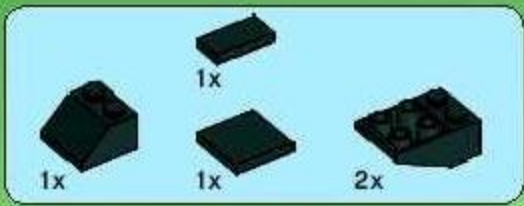

12

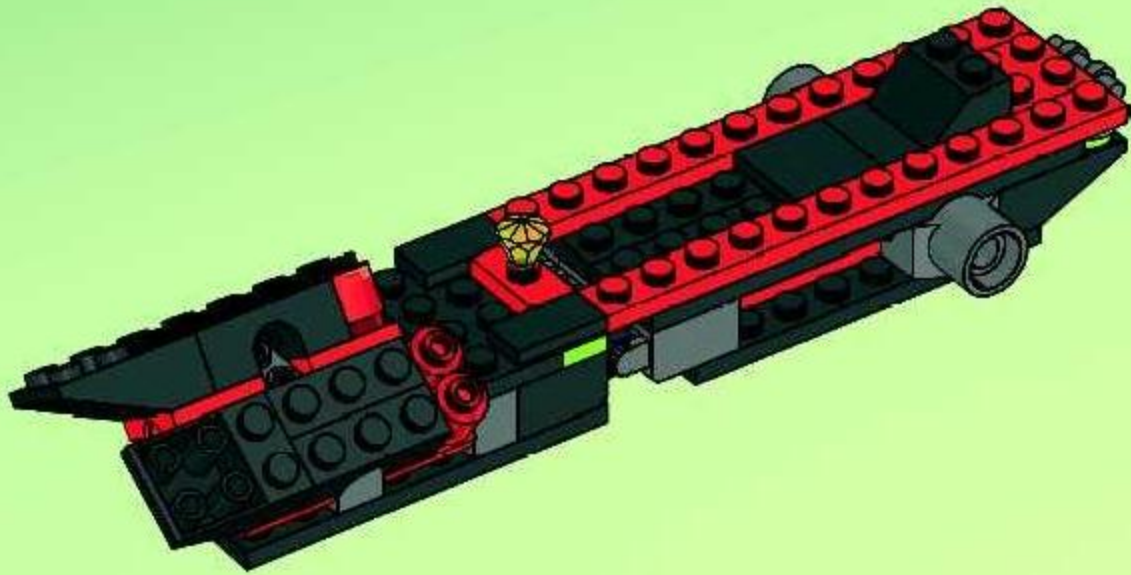

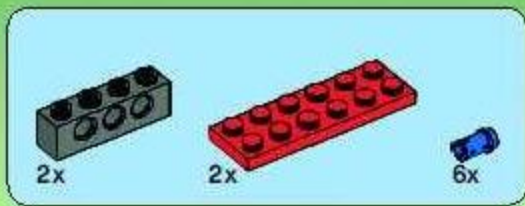

13

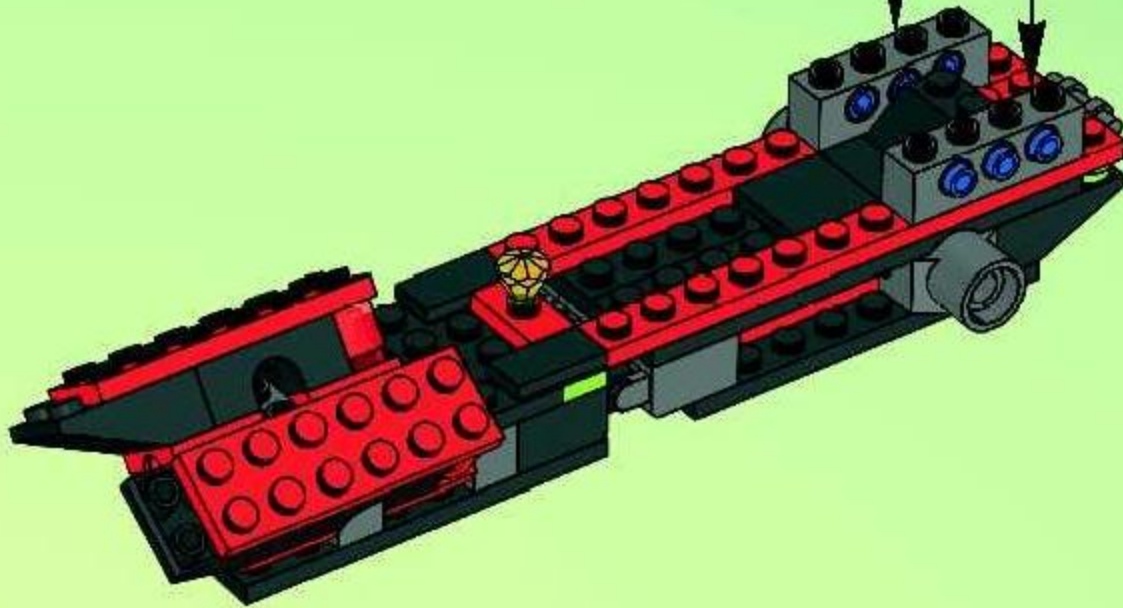
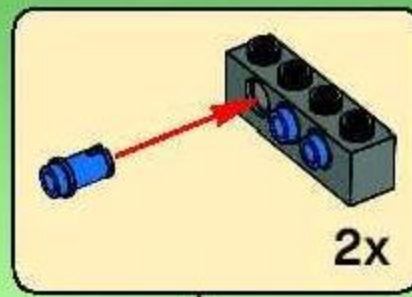

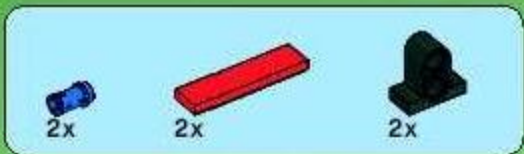

14

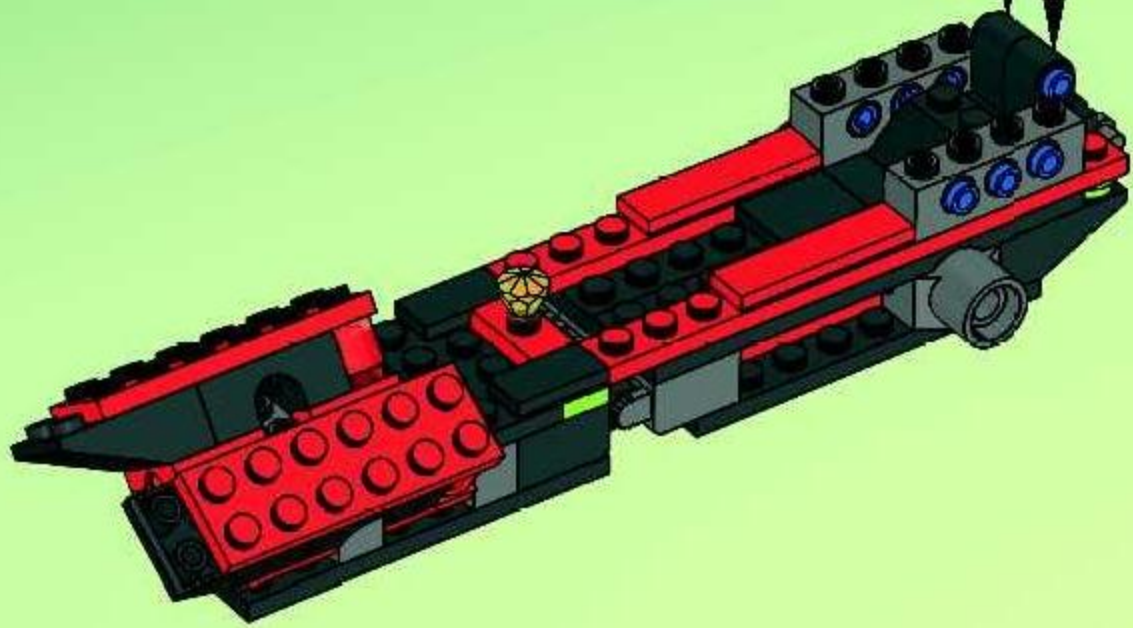
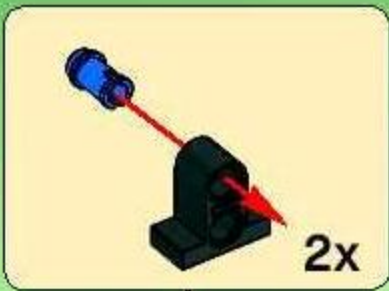



1x

15

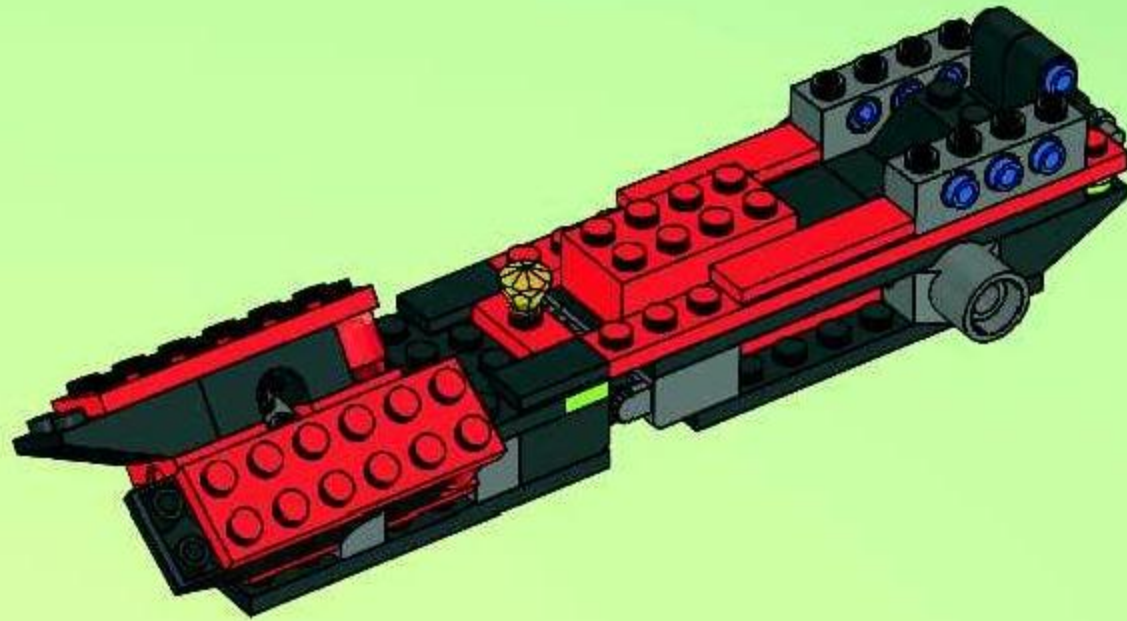



16

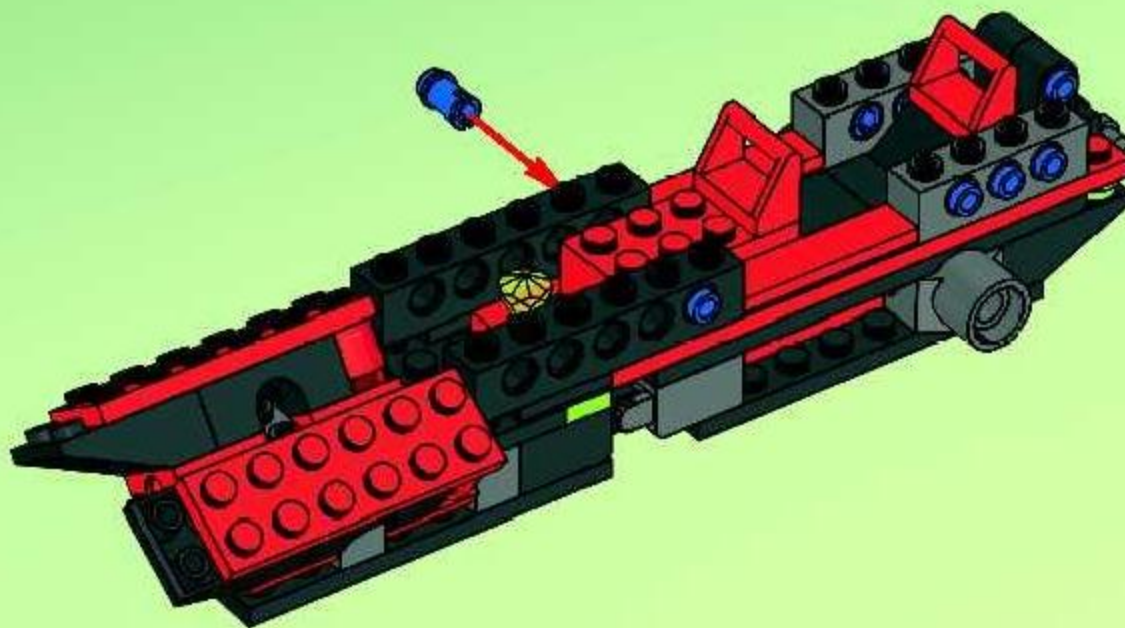

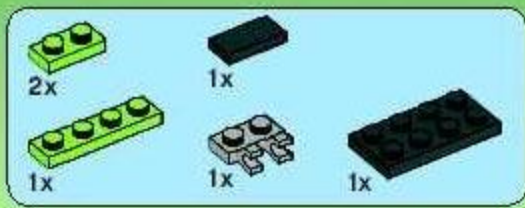

17

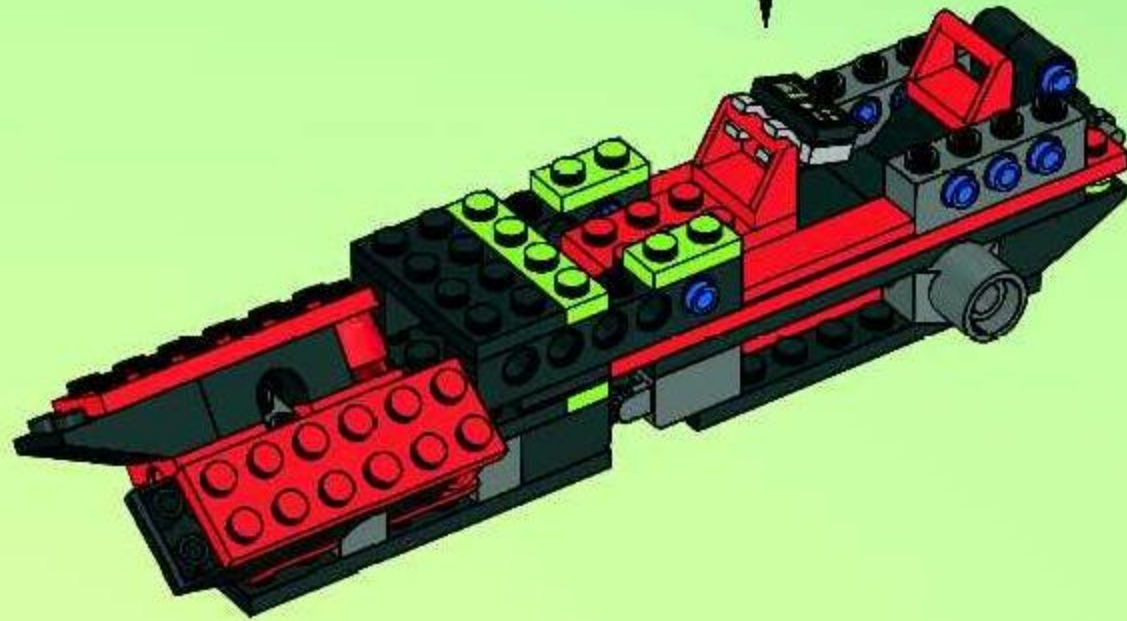
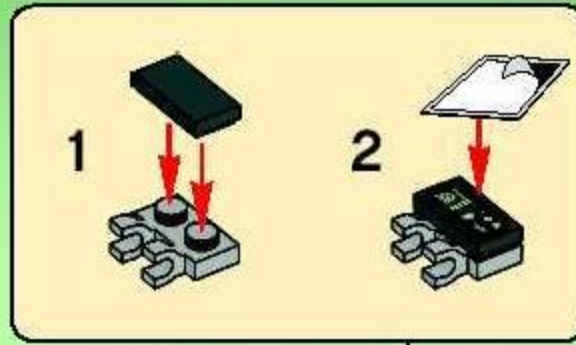

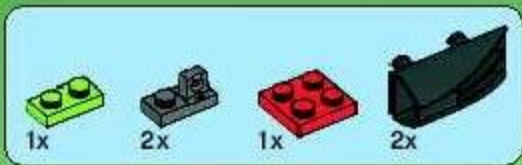

18

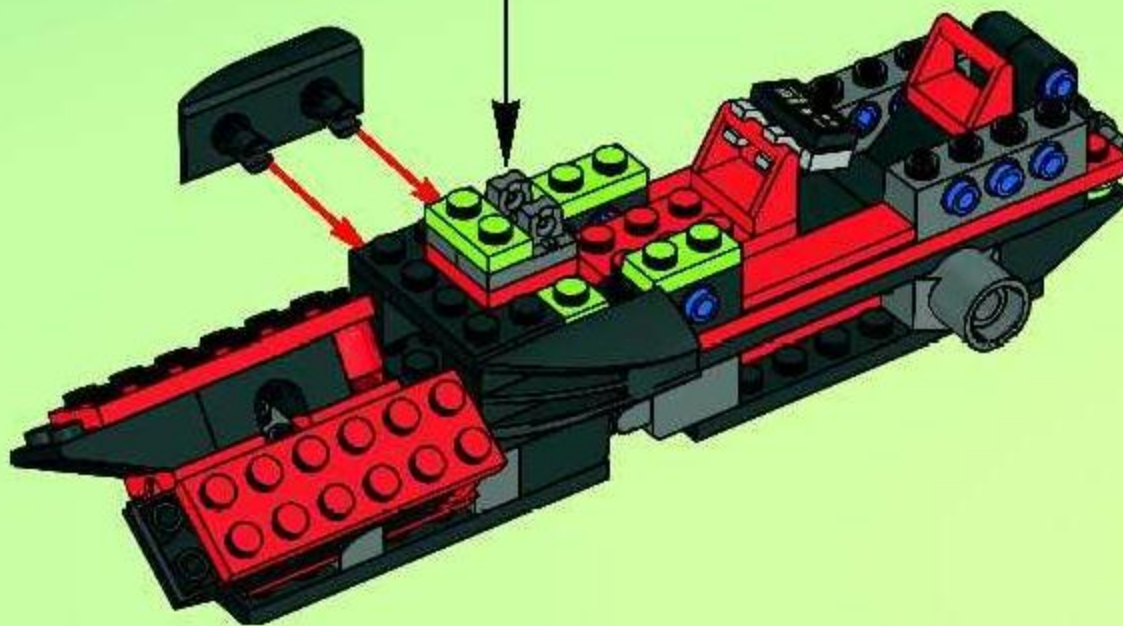



19

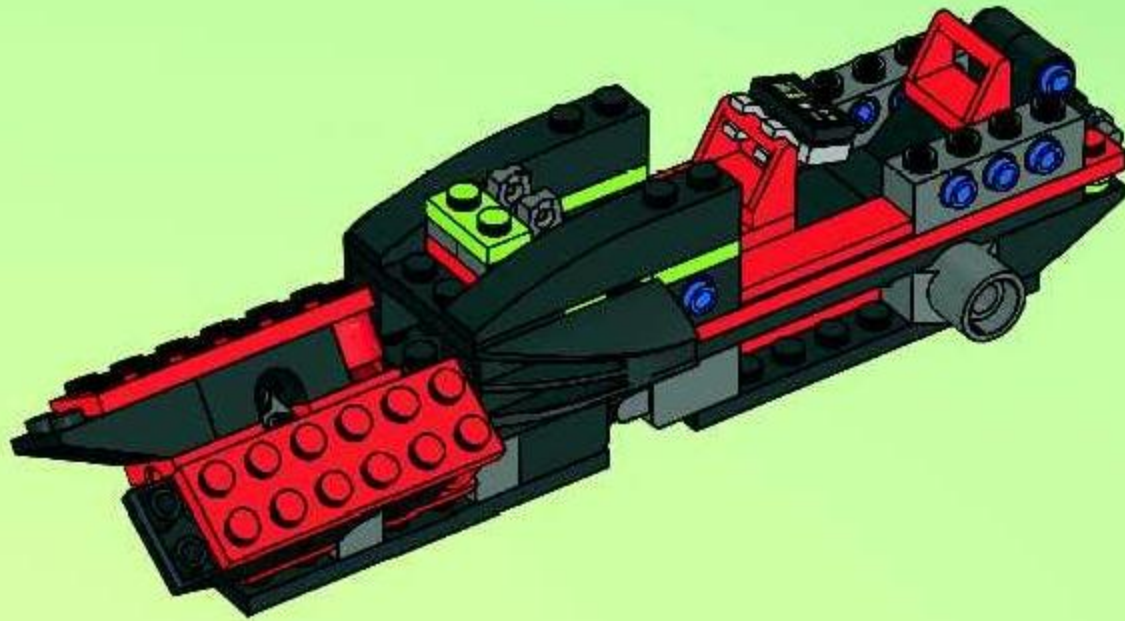

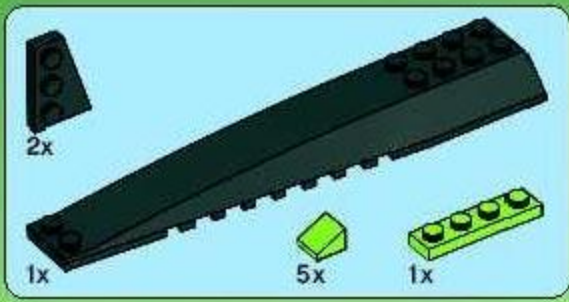

20

1

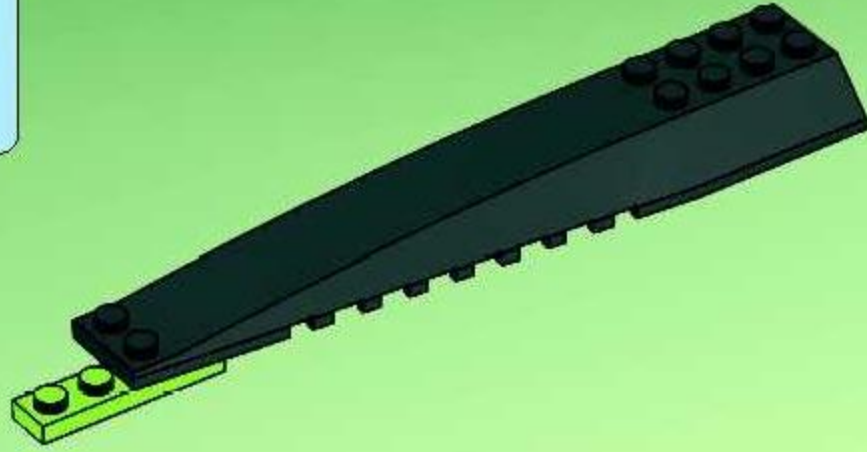

2



3



4

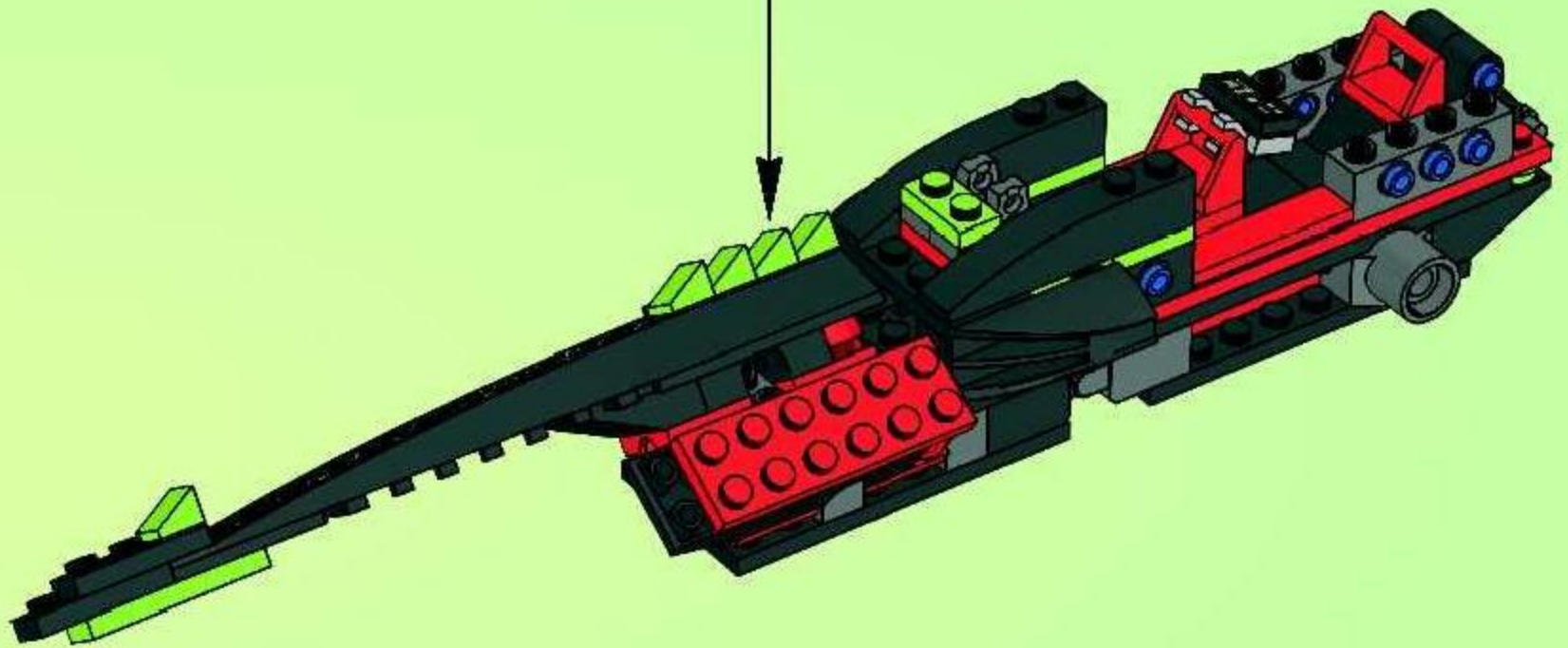
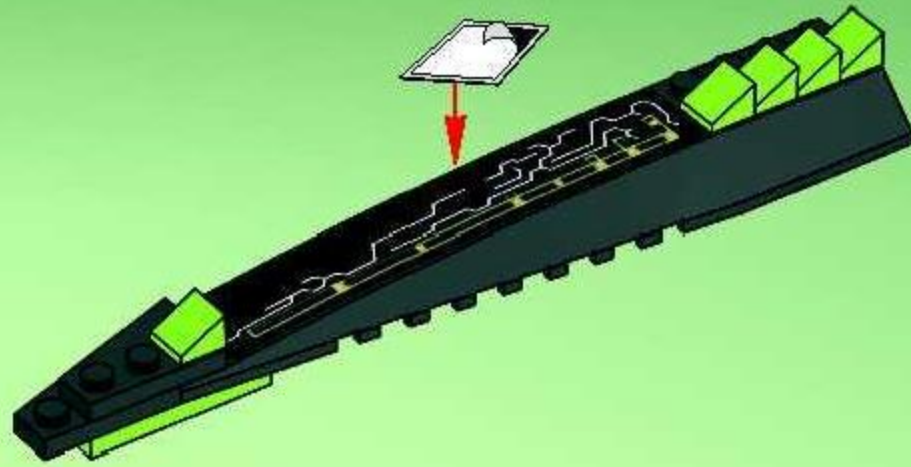

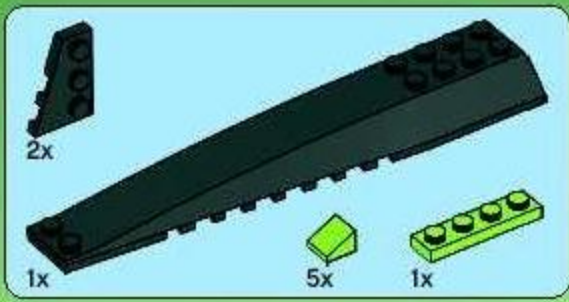

21

1



2



3

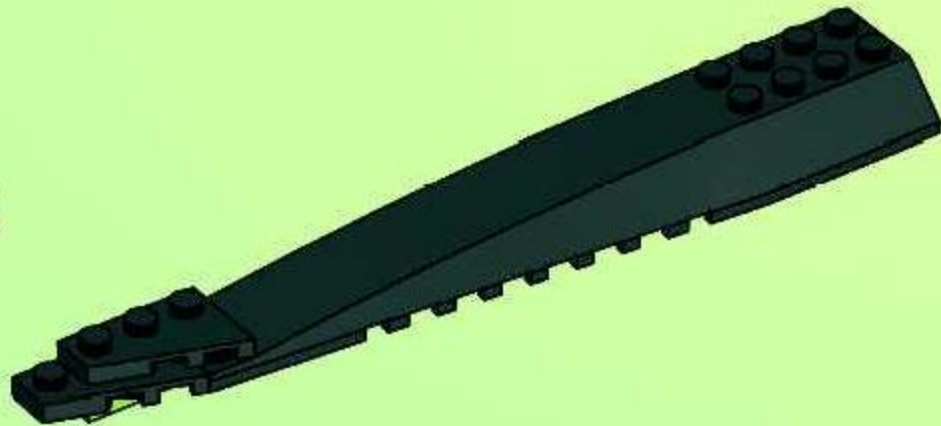

4

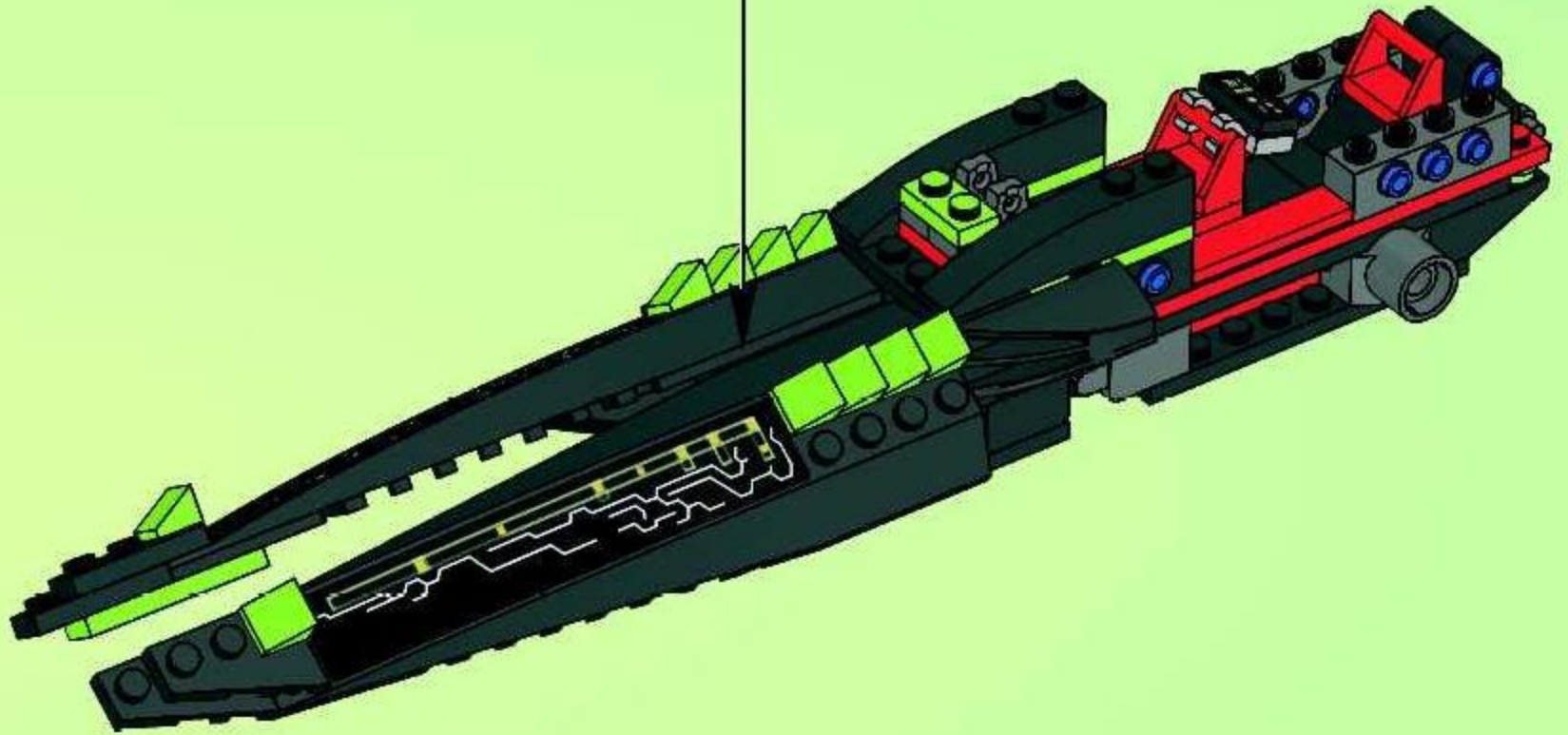
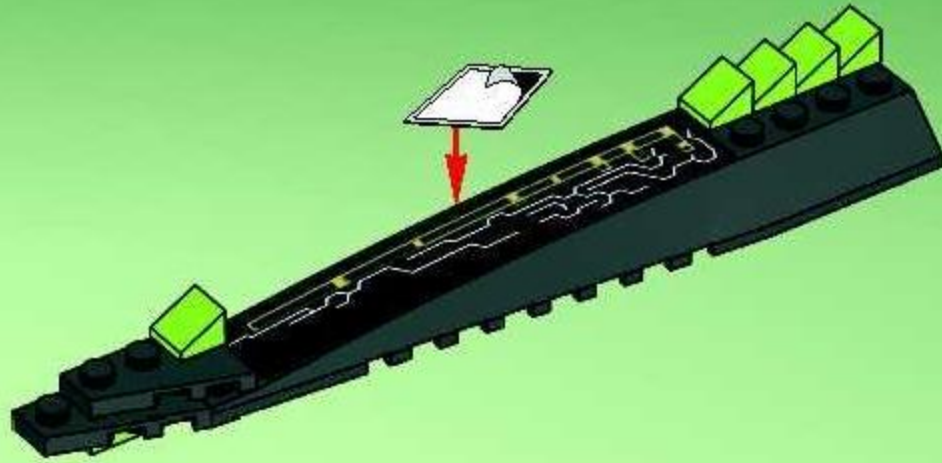



22

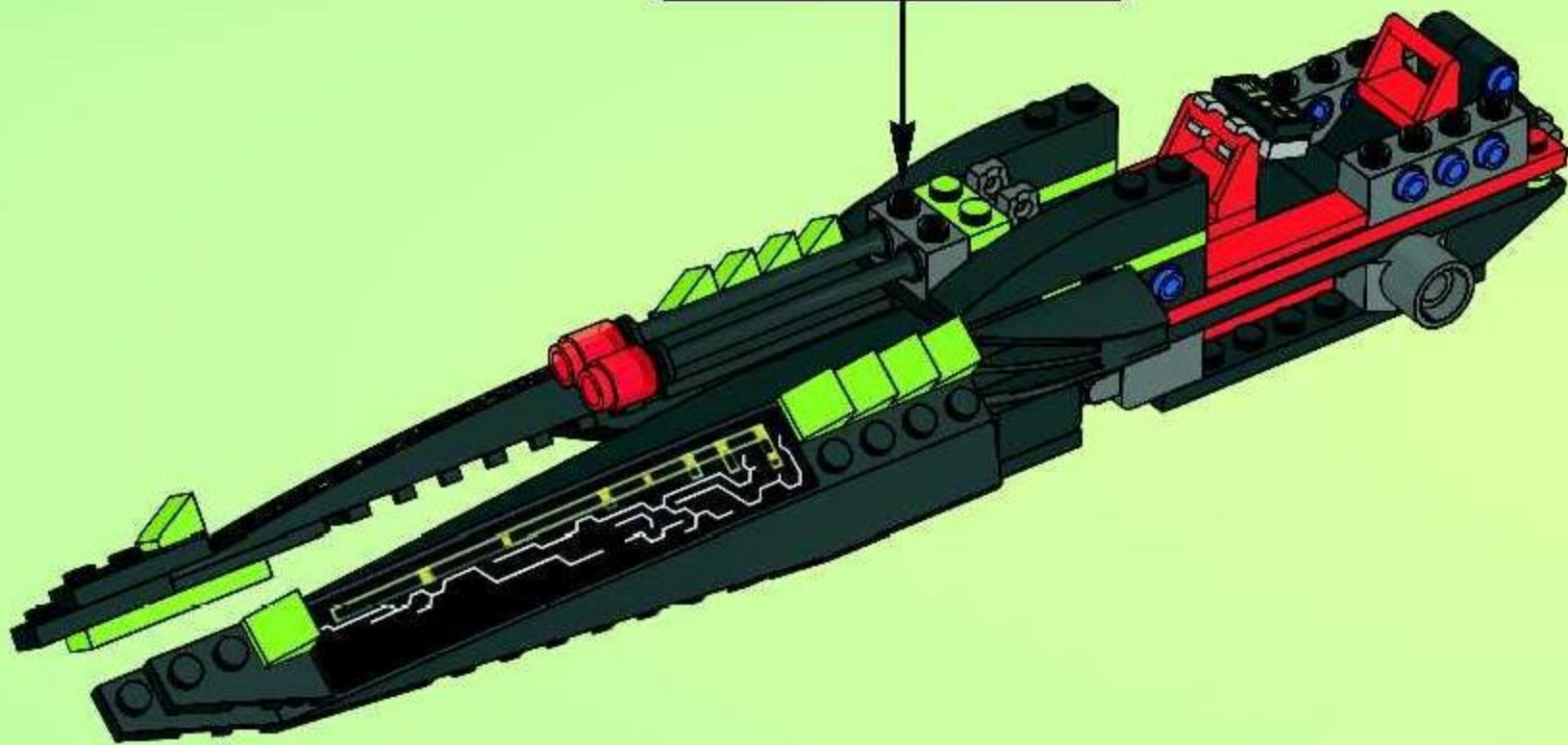
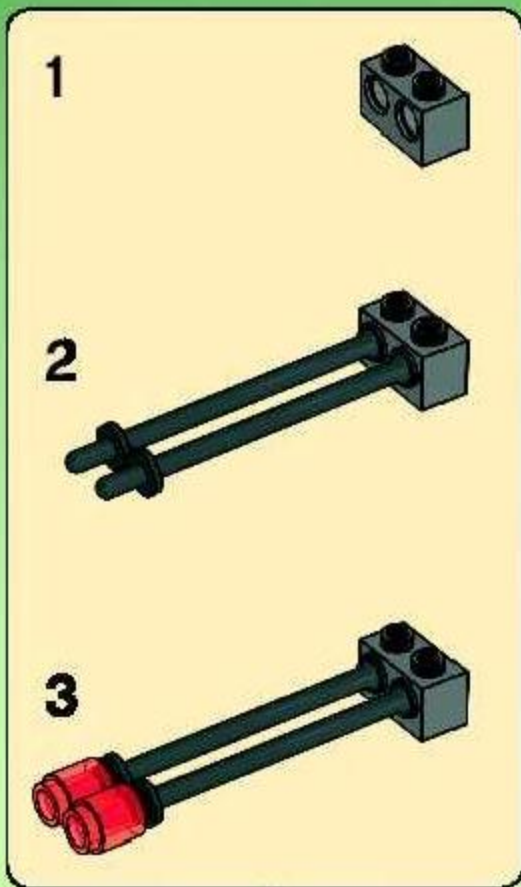



1x



2x

23

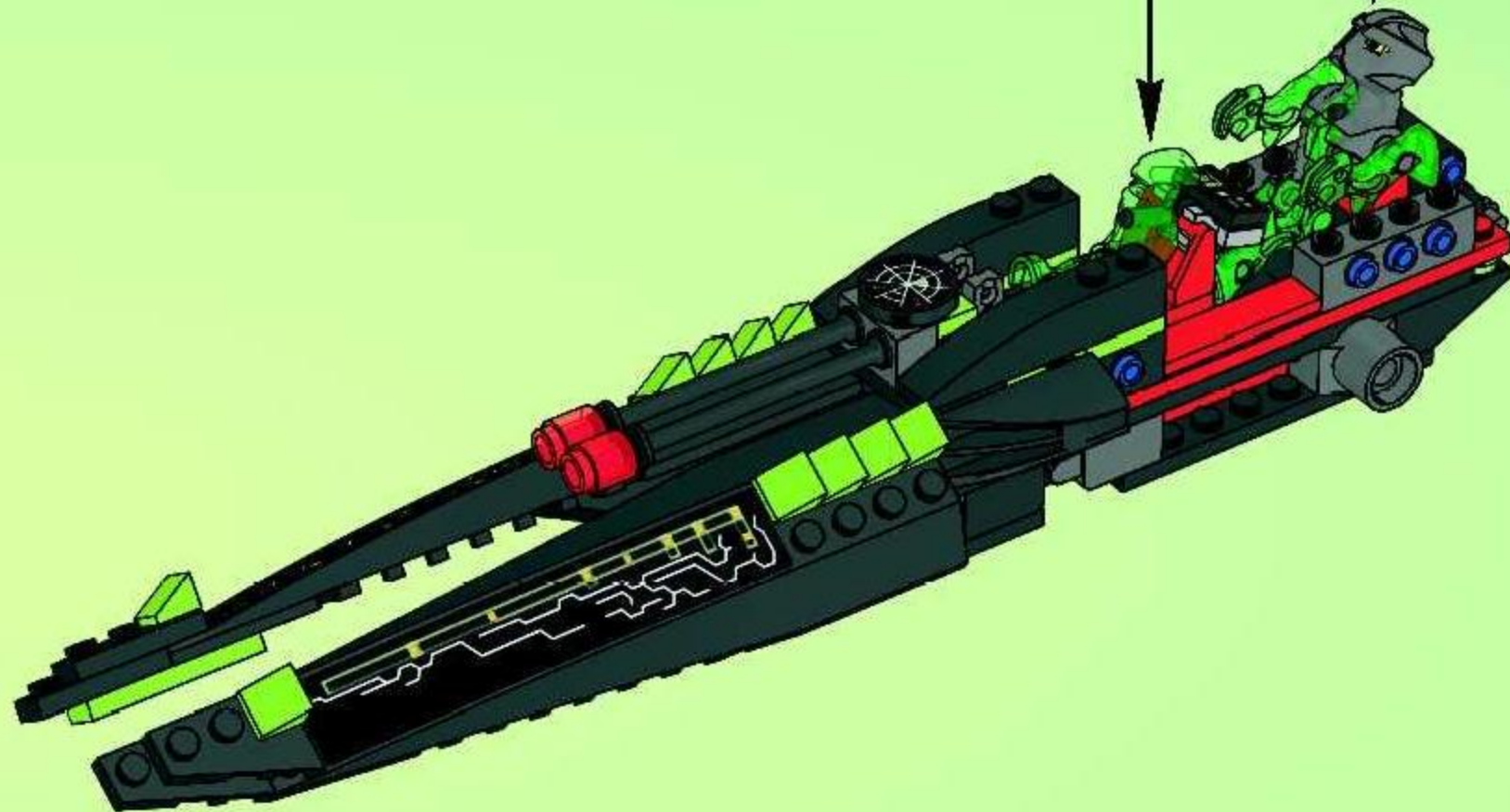
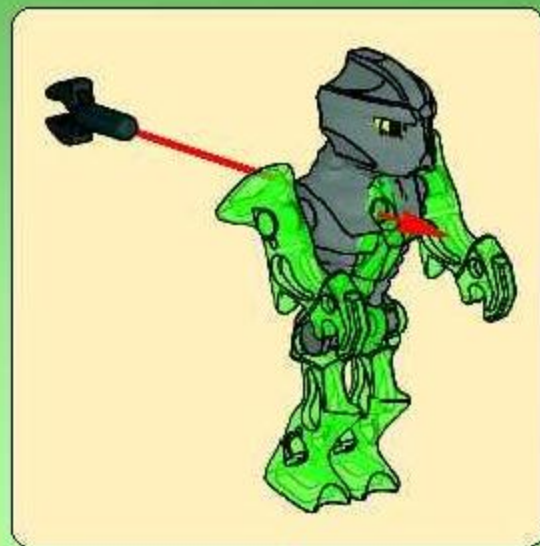
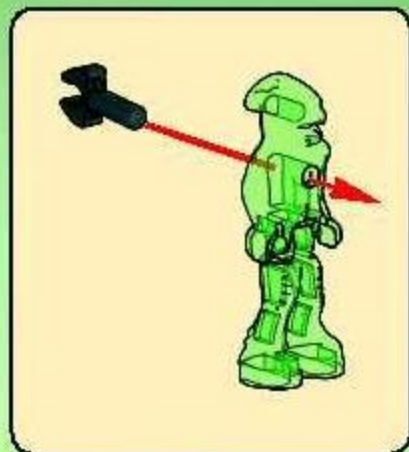

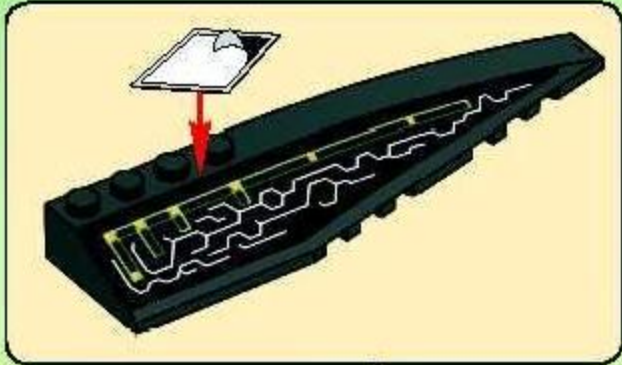
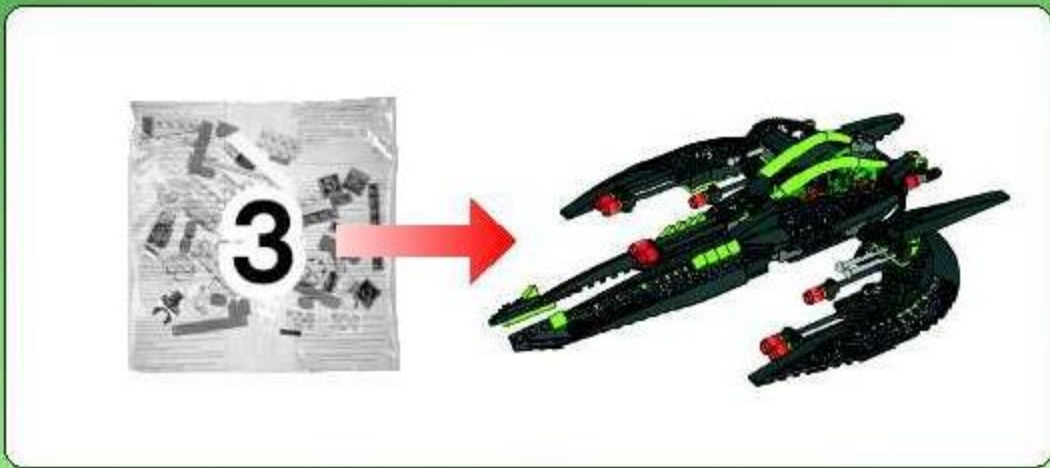

24

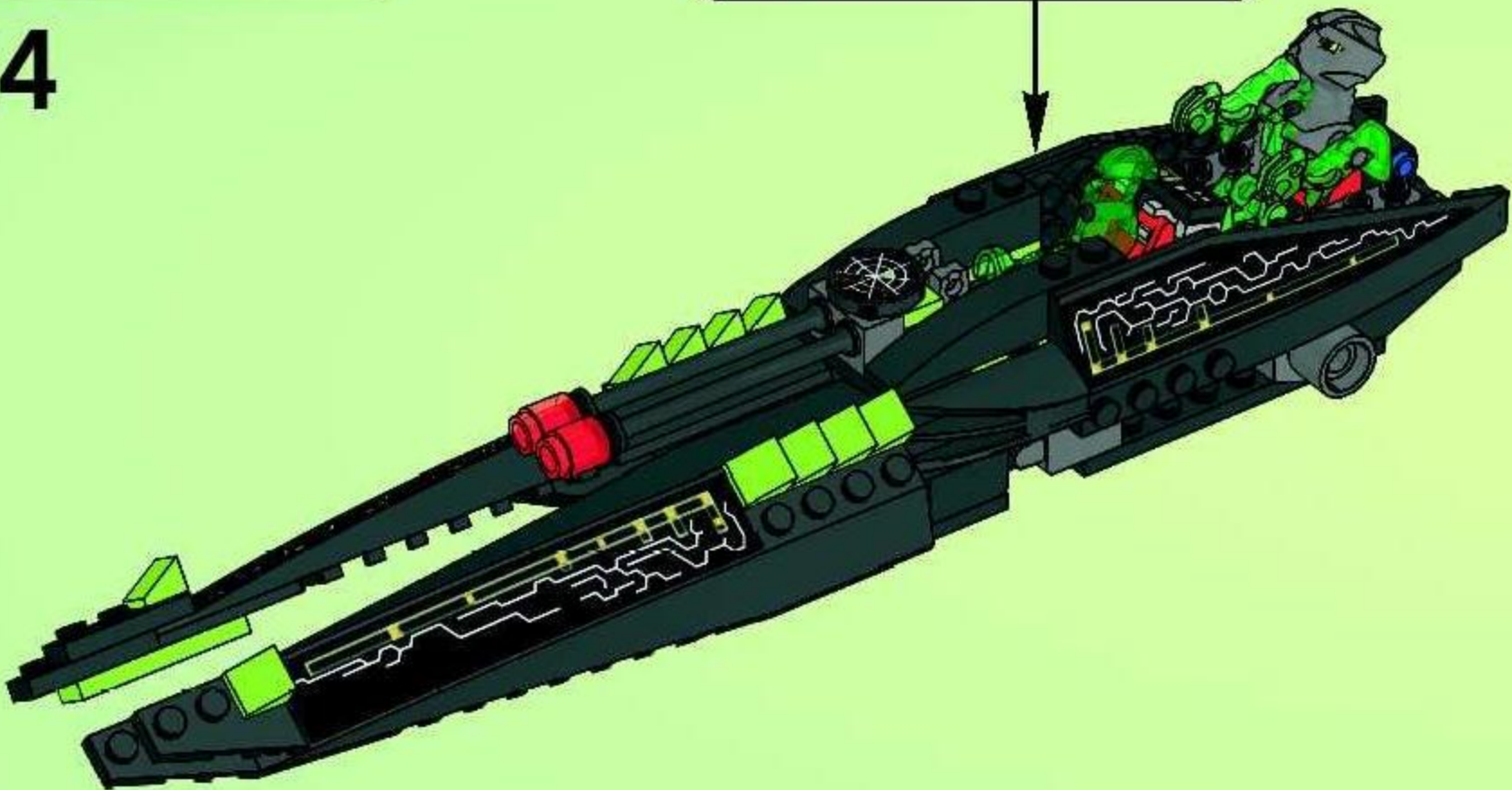



25

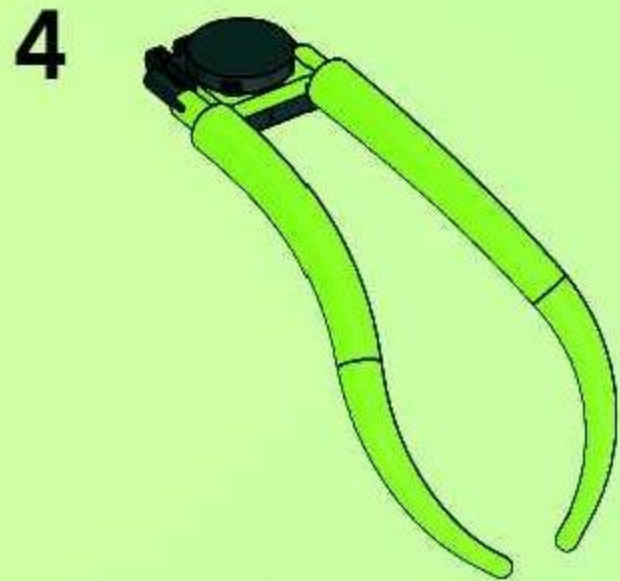
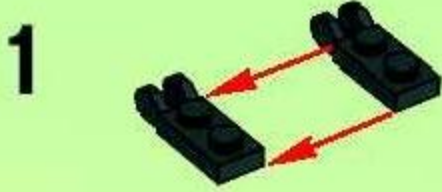

5

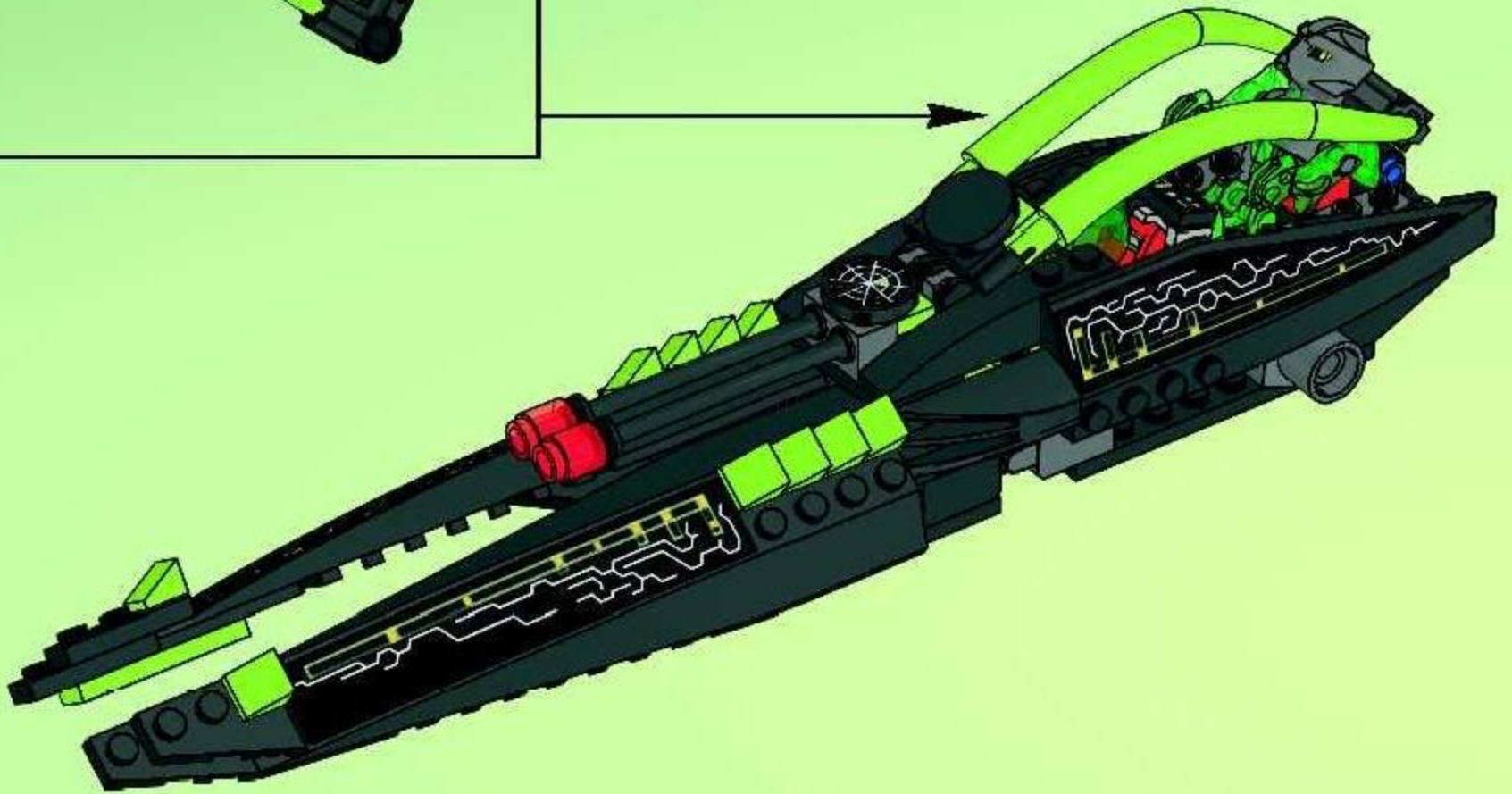



26

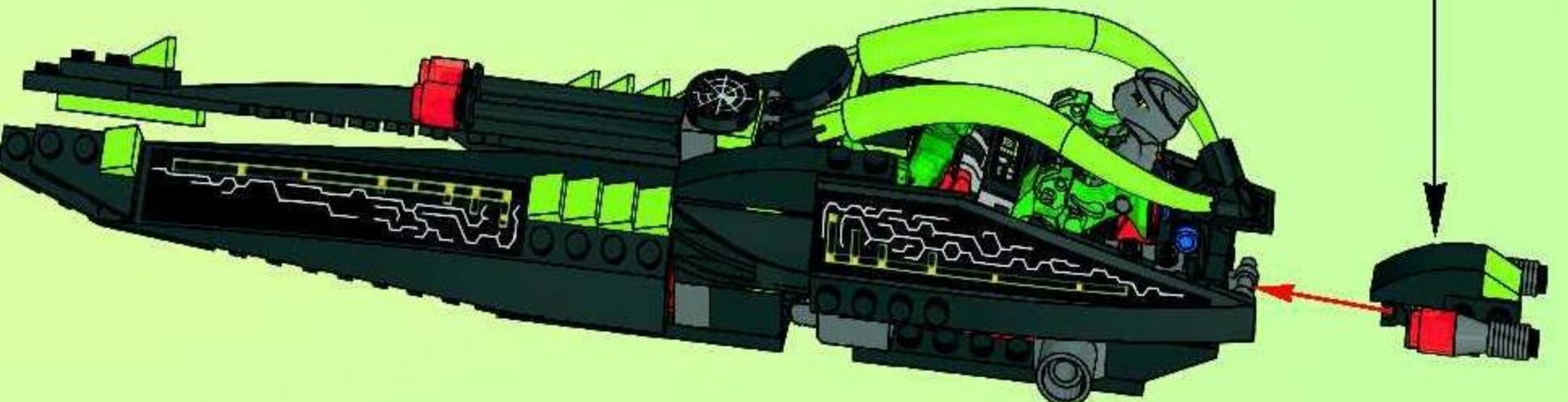
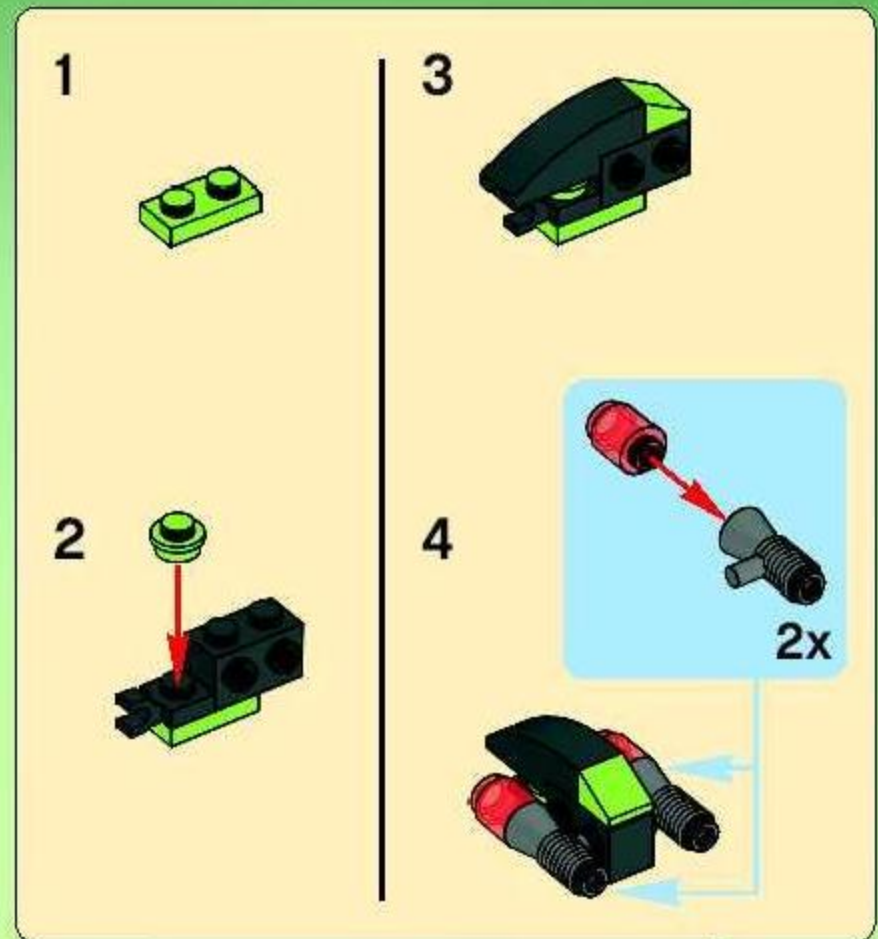

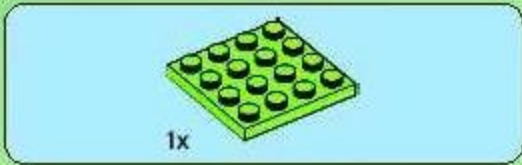

1

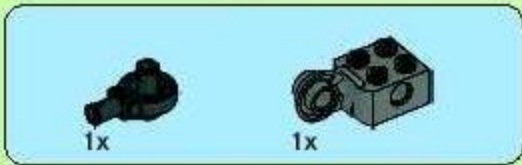
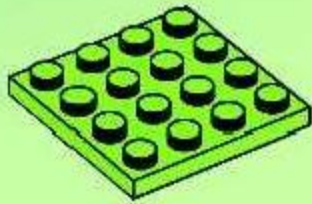

2

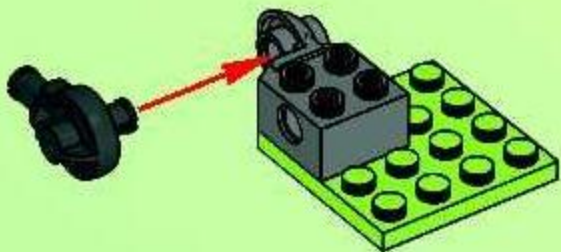

3

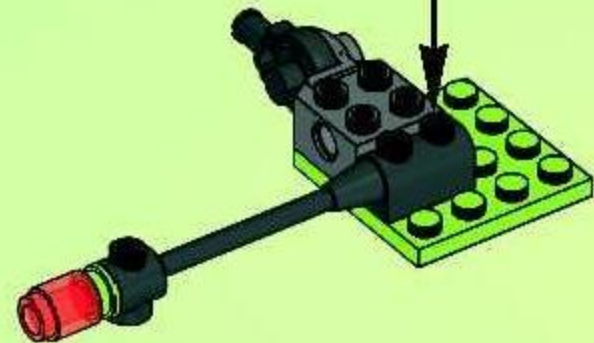
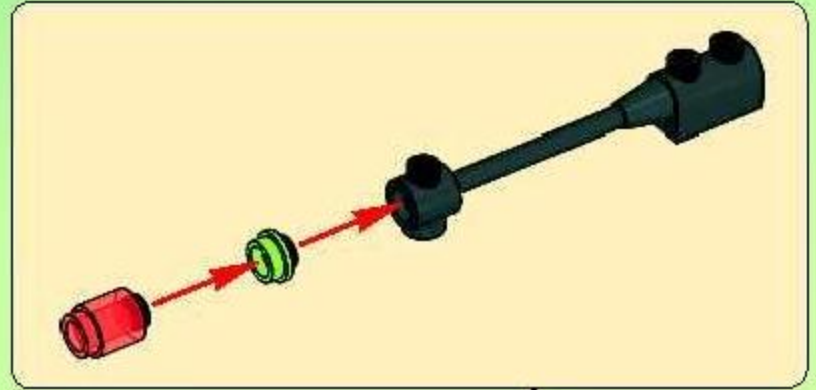

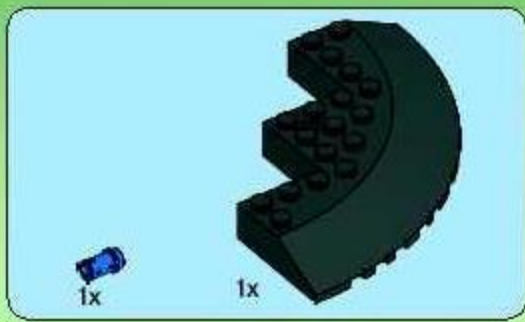

4

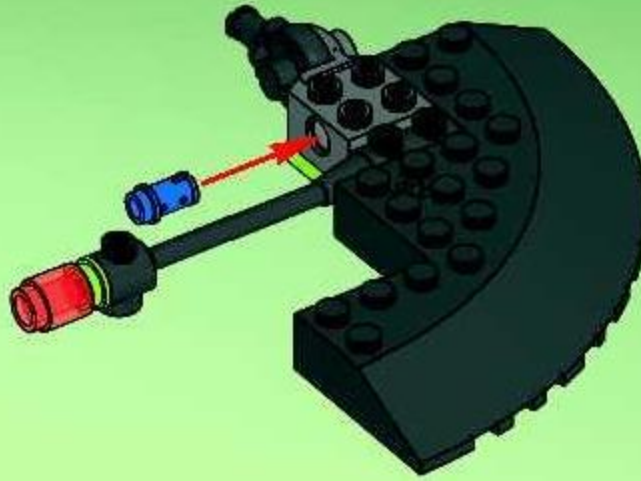

5

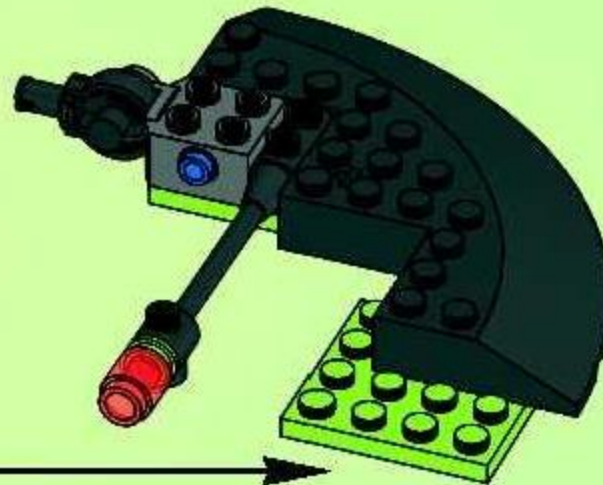



1x

6



7

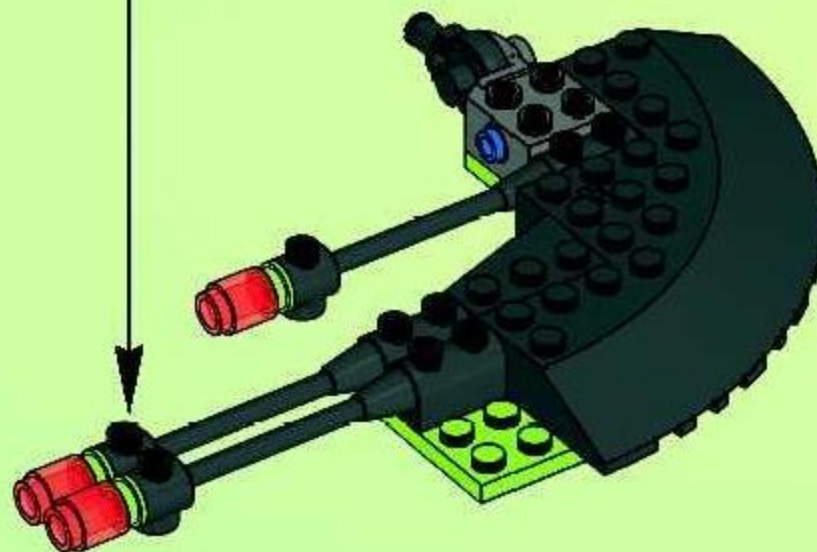
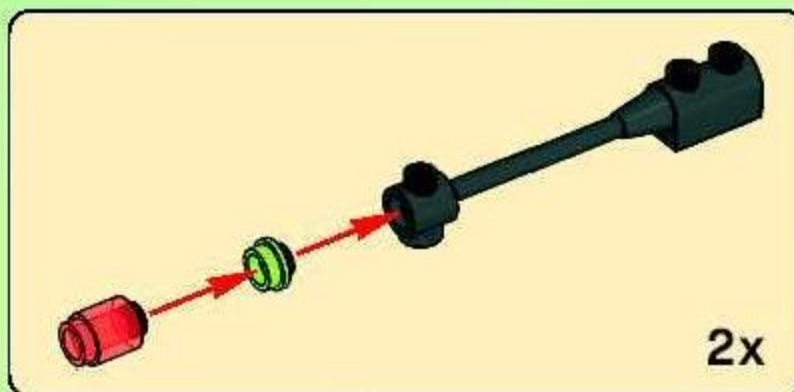



8

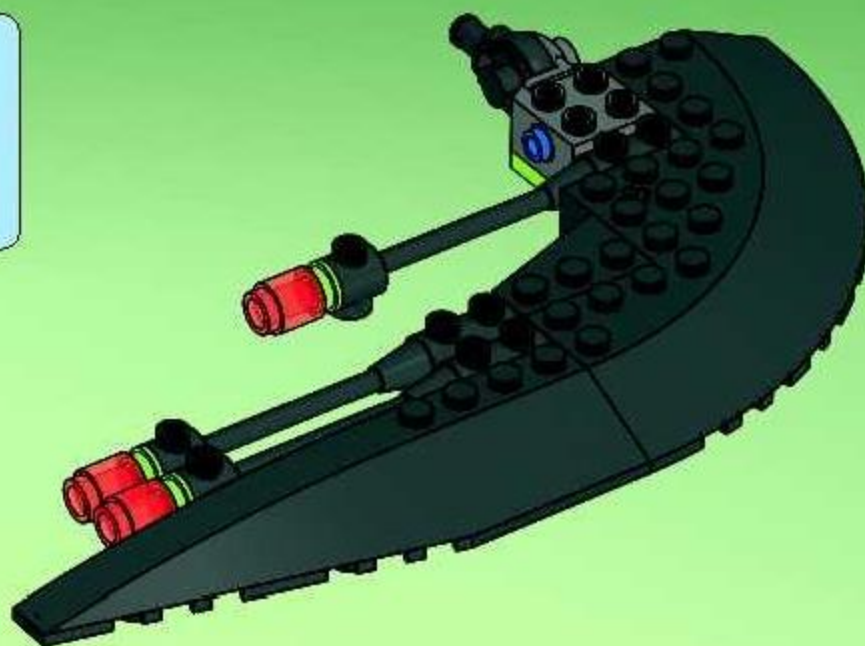

9

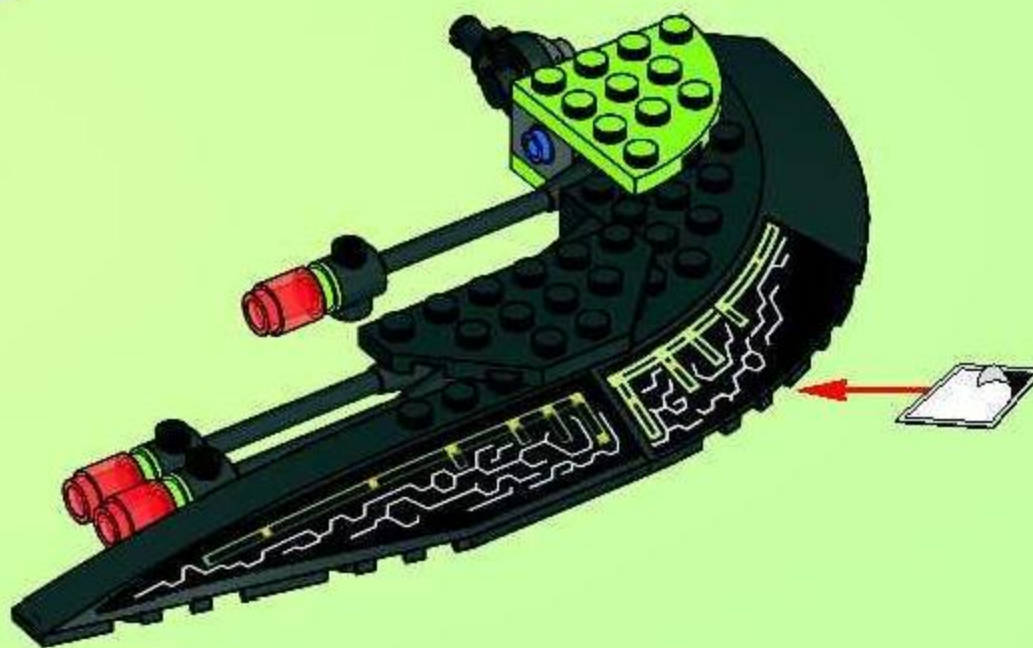



10

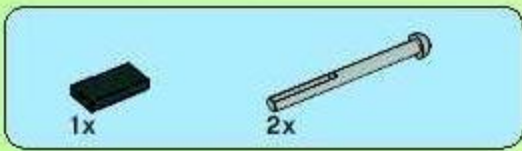

11



27

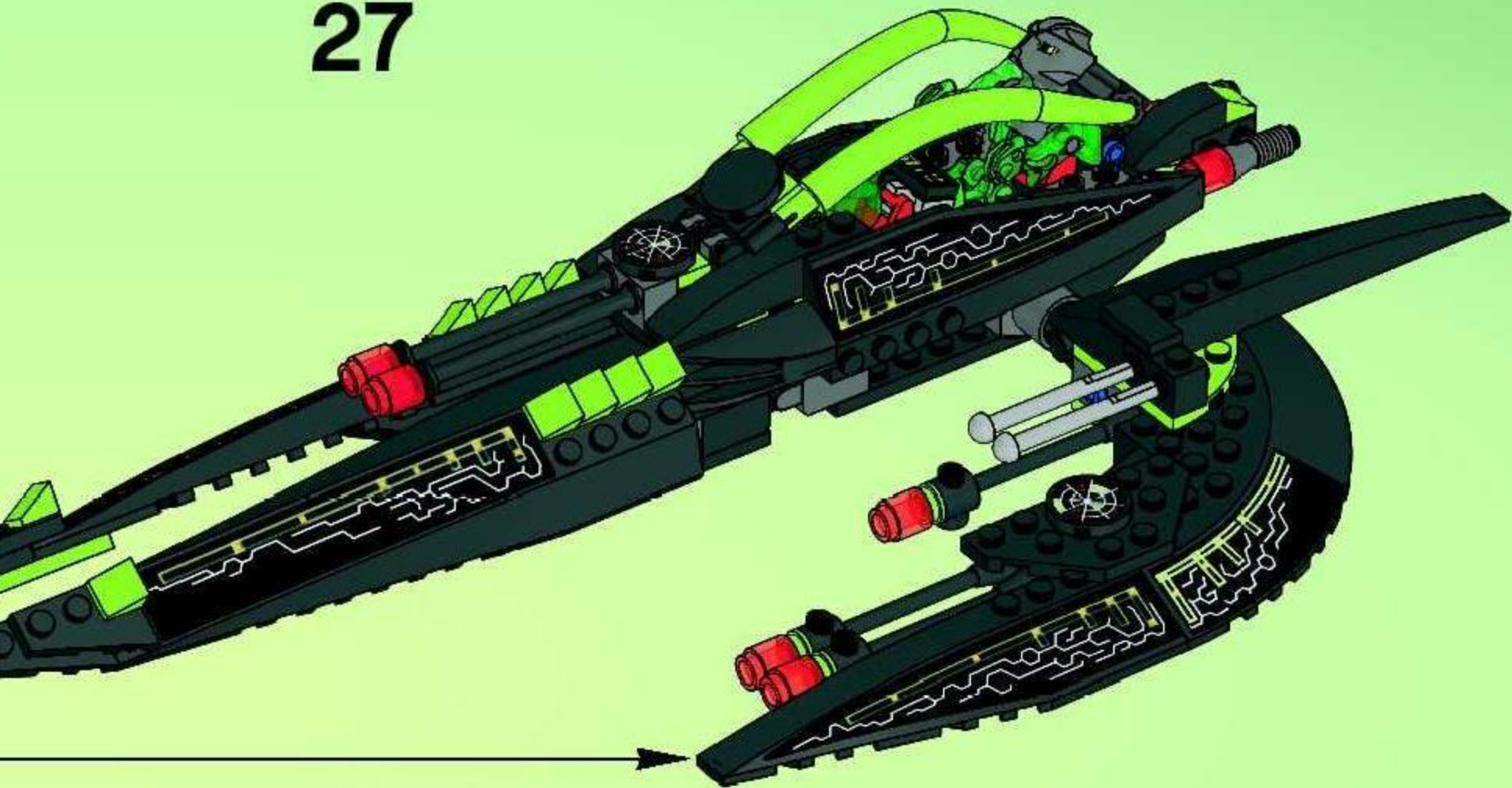

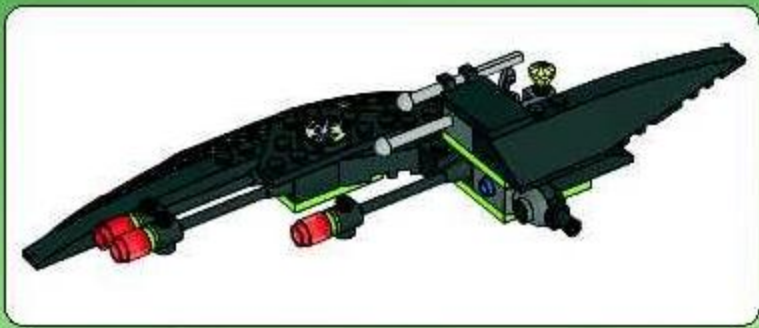

1

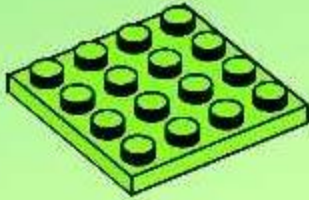

2

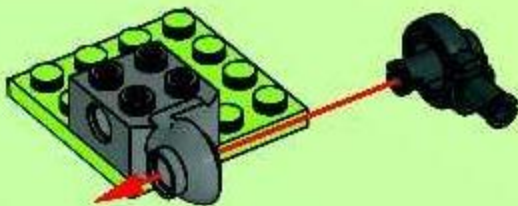

3

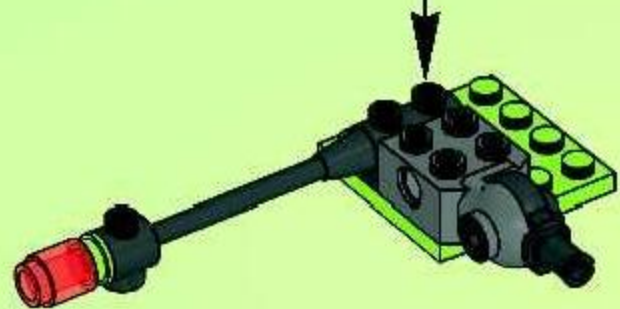
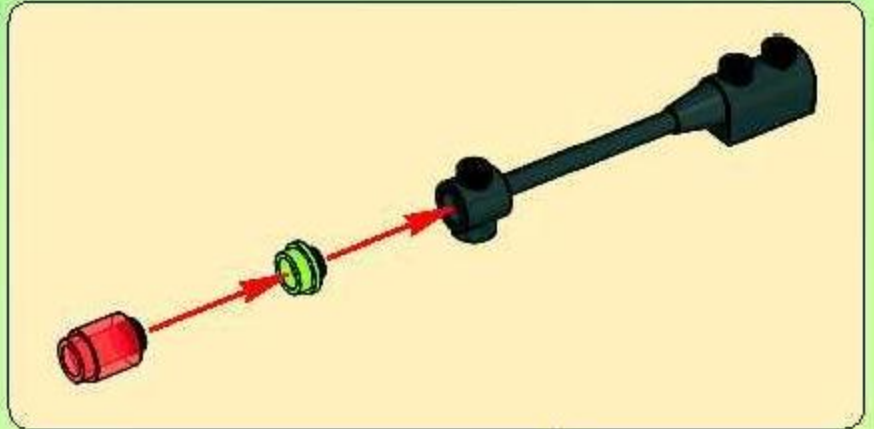

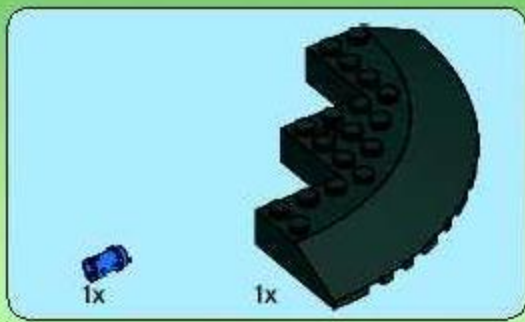

4

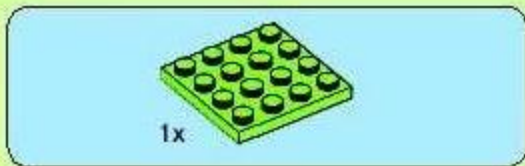
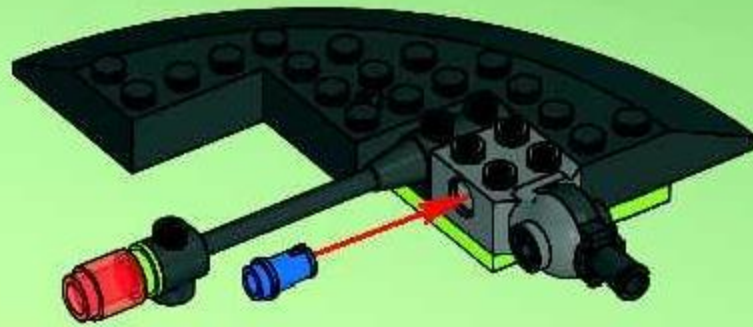

5

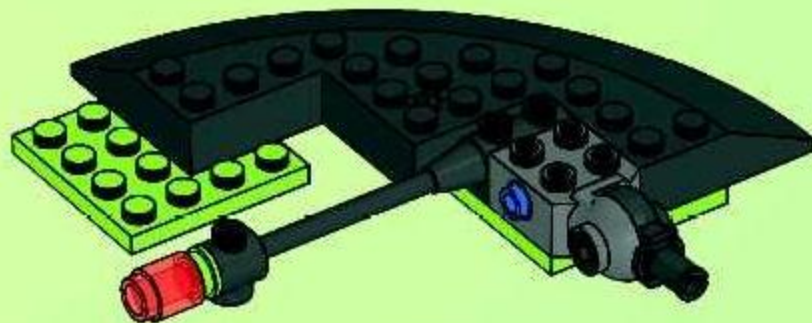

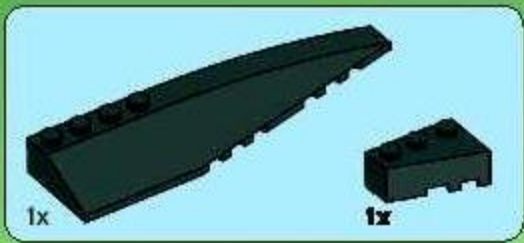

6

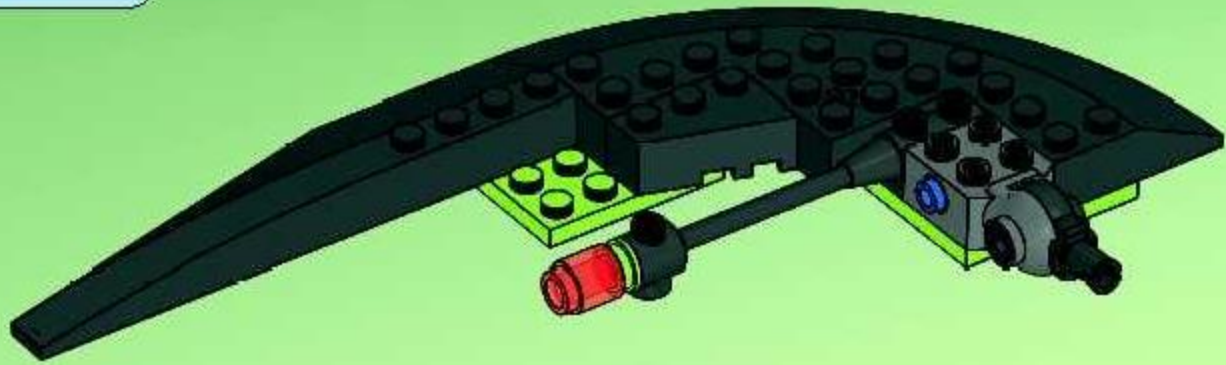

7

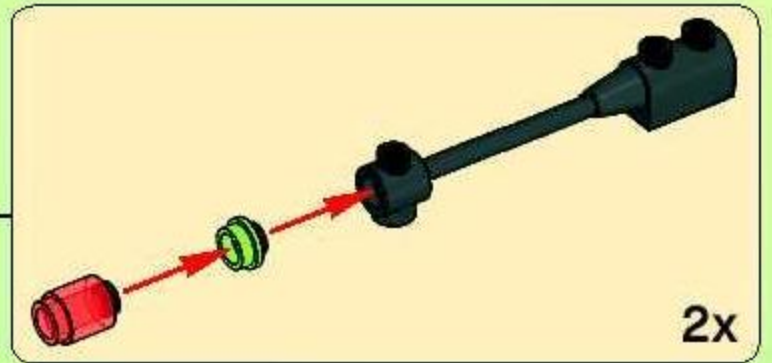
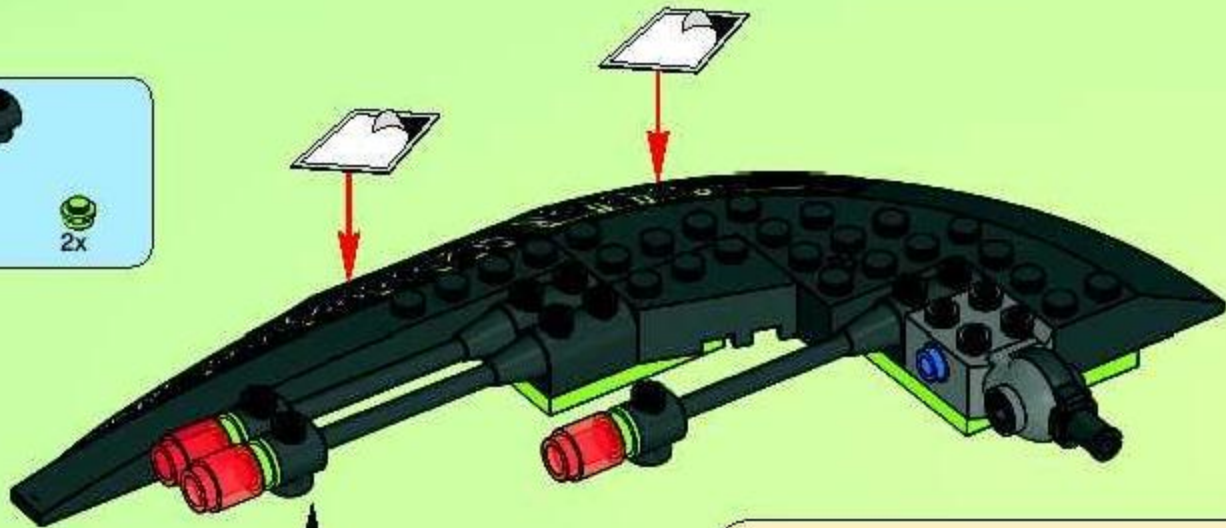



8

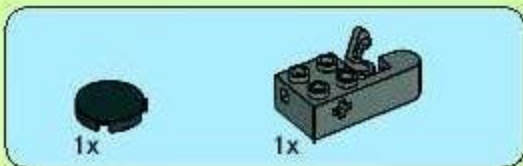
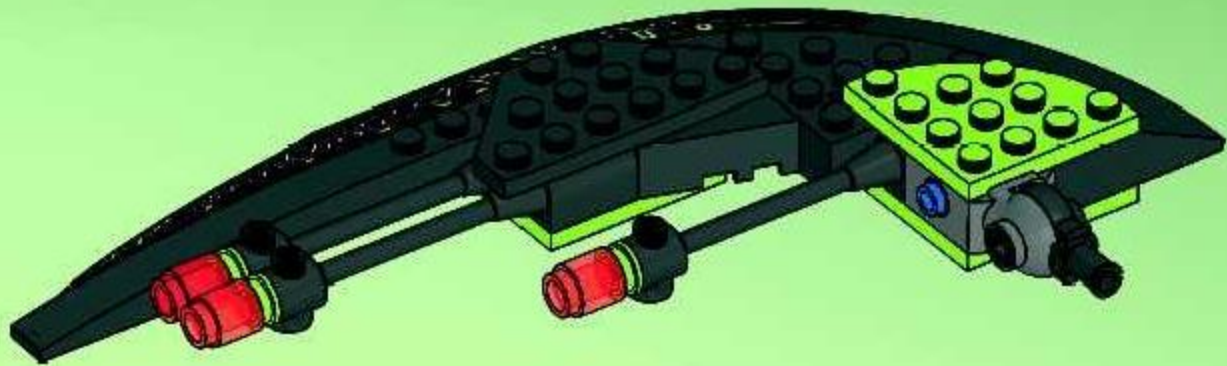

9

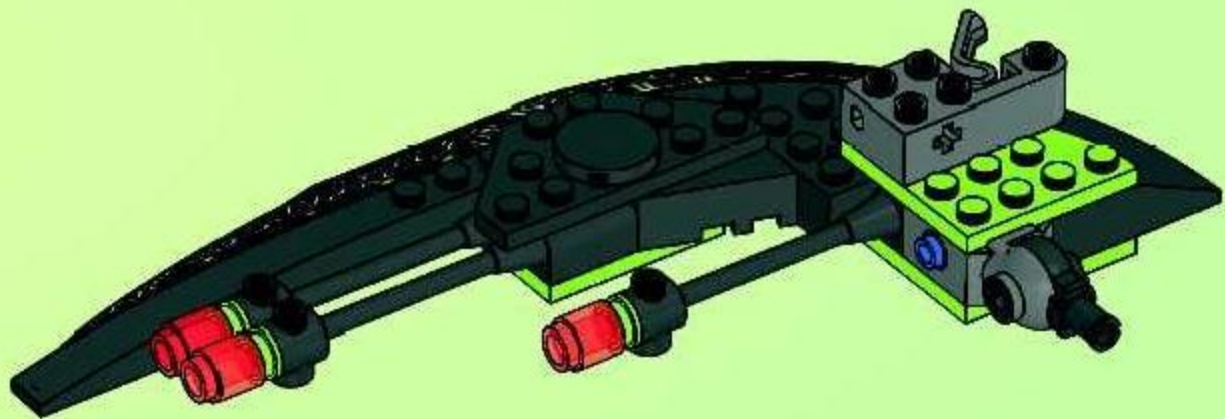



10

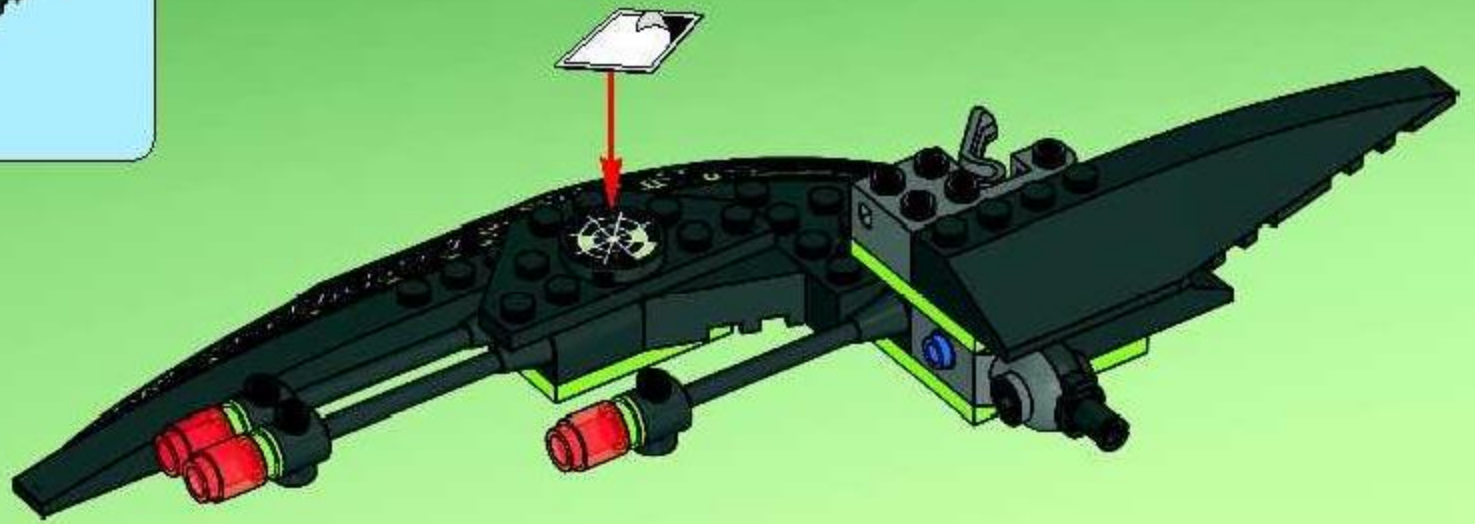

11

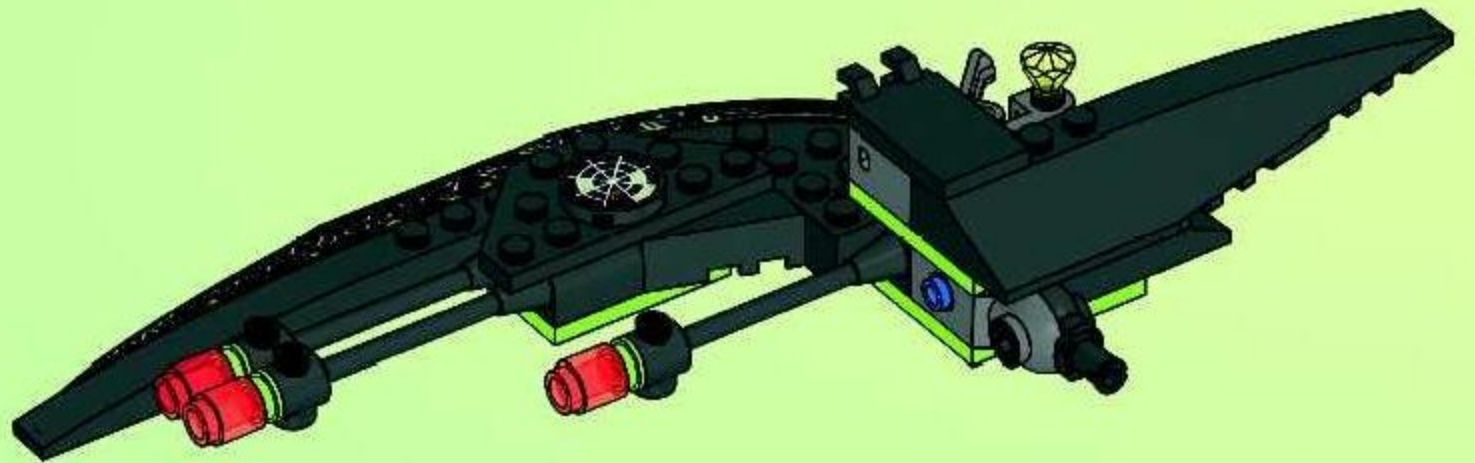

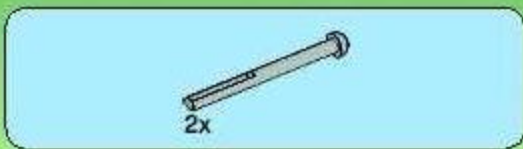

12

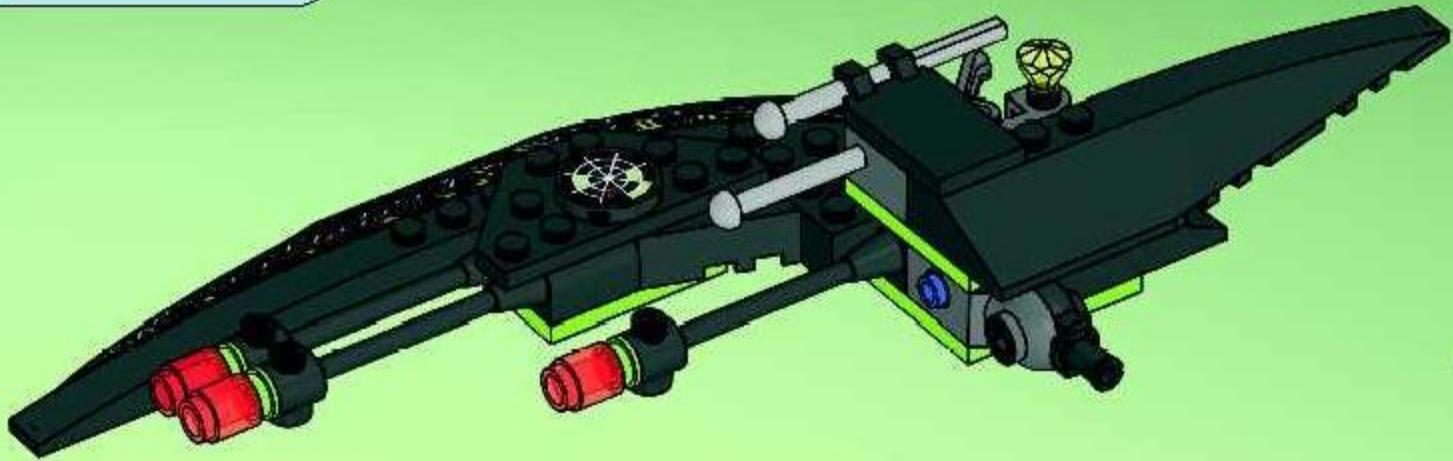

1

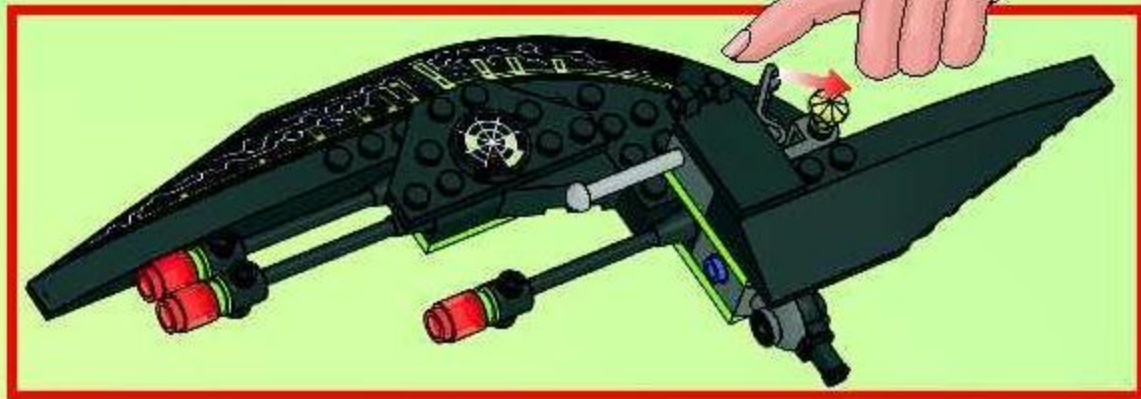

2

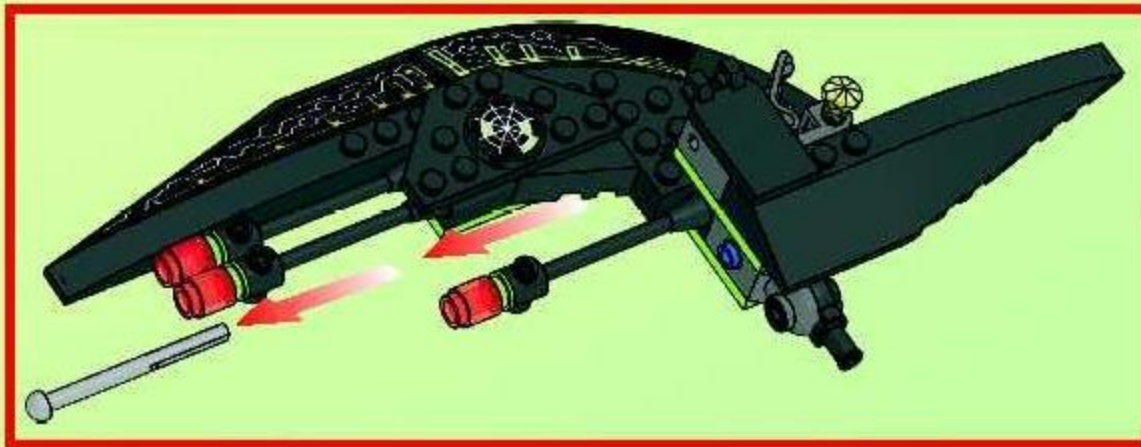

28





29





LEGO

MARS MISSION

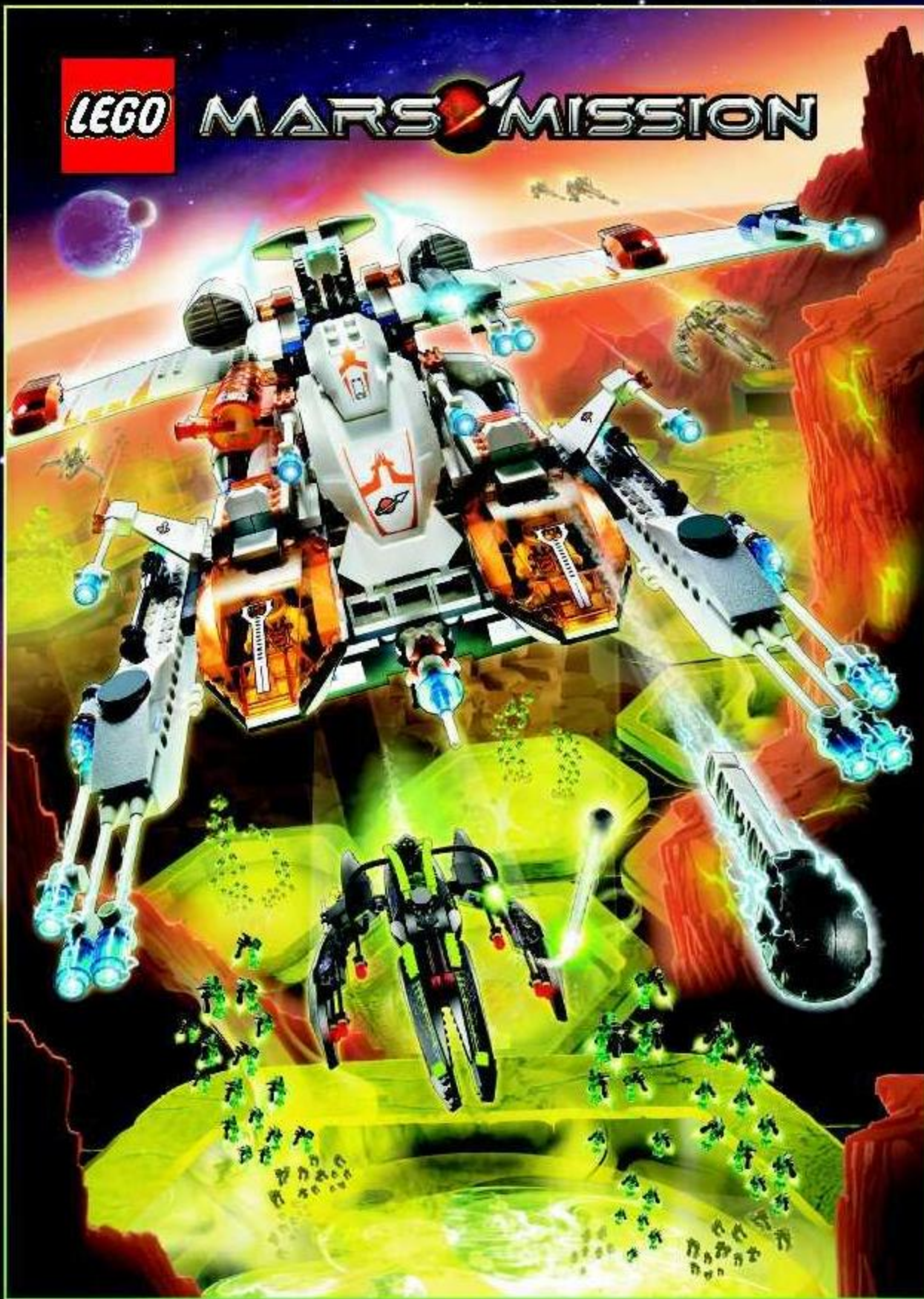



1x
4517925

3x
302326

2x
4183060

2x
383226

1x
4297713

2x
4180536

2x
4180508

5x
302026

2x
379526

2x
303526

2x
303926

1x
4527766

1x
4526931

4x
374728

3x
4527983

3x
4527984

2x
4229602

4x
4289538

2x
4144024

2x
4209159

2x
368026

4x
4527838

1x
4501926

1x
4534488

2x
4504566

5x
4164037

4x
4187743

4x
4504850

2x
4504705

11x
4504372

9x
4183133

2x
4508460

1x
4261357

4x
4525870

1x
4515173

2x
4211439

1x
4211510

1x
4210762

4x
4210724

2x
4225973

2x
4225975

1x
4523806

1x
4514559

1x
4211048

2x
4210698

1x
4211007

1x
4210660

2x
4210726

2x
4217558

1x
4261117

1x
4211051

4x
4213607

4x
4114505

1x
4505156

2x
4505182

1x
4107106

1x
4534442

Customer Service
Kundenservice
Service Consommateurs
Servicio Al Consumidor

www.lego.com/service or dial



LEGO

MARS MISSION



7644



7645



7646



7647



7648





BATMAN™

THE VIDEOGAME

COMING SEPTEMBER 2008



PlayStation 2

PLAYSTATION 3



© 2008 Warner Bros. Entertainment Inc. All rights reserved. LEGO, the LEGO logo, the Brick and Knob configuration, and the Minifigure are trademarks of the LEGO Group. Batman, the Batman logo, and the DC logo are trademarks of DC Comics. All other trademarks are the property of their respective owners. For more information on the LEGO Group, visit www.lego.com. For more information on DC Comics, visit www.dccomics.com. For more information on the LEGO Batman minifigures, visit www.lego.com/batman. For more information on the LEGO Batman videogame, visit www.lego.com/batmanvideogame. For more information on the LEGO Batman videogame, visit www.lego.com/batmanvideogame. For more information on the LEGO Batman videogame, visit www.lego.com/batmanvideogame.

GB **IMPORTANT:** Never modify the elements or use other projectiles than provided with this toy.

DE **WICHTIG:** Die Elemente dürfen nicht verändert werden. Es dürfen ausschließlich die mit dem Spielzeug mitgelieferten Geschosse verwendet werden.

FR **IMPORTANT :** Ne jamais modifier les éléments ni utiliser d'autres projectiles que ceux fournis avec ce jouet.

IT **IMPORTANTE:** non modificare gli elementi o utilizzare proiettili non forniti con questo prodotto.

NL **BELANGRIJK:** Verander niets aan de elementen en gebruik geen andere projectielen dan de bij het speelgoed geleverde.

ES **IMPORTANTE:** No modifique los elementos ni utilice otros proyectiles diferentes a los suministrados junto con este juguete.

DA **VIGTIGT:** Elementerne må ikke ændres, og der må ikke bruges andre projektiler end dem, der følger med legetøjet.

FI **TÄRKEÄÄ:** Älä koskaan tee osiin muutoksia tai käytä leluissa muita kuin sen sisältämiä ammuksia.

SV **VIKTIGT:** Modifiera aldrig delarna och använd aldrig andra projektiler än de som medföljer denna leksak.

PT **IMPORTANTE:** Nunca modifique os elementos nem utilize projecteis que não tenham sido fornecidos com este brinquedo.

EL **ΣΗΜΑΝΤΙΚΟ:** Ποτέ μην τροποποιείτε τα στοιχεία του παιχνιδιού και μην χρησιμοποιείτε άλλα βλήματα εκτός από αυτά που συνοδεύουν αυτό το παιχνίδι.

JA **重要:** 部品を改造したり、本製品に付属の発射体以外のものを使用しないようにしてください。

ZH **重要提示:** 切勿更改组件或使用并非由本玩具附带的弹丸。

KO **중요할:** 이물 부품을 수정하거나 이 완구의 함께 제공된 것이 아닌 발사체는 결코 사용하지 마십시오.

RU **ВАЖНО:** запрещается вносить изменения в элементы или использовать другие снаряды, отличные от тех, которые поставляются с данной игрушкой.

PL **WAŻNE:** Nigdy nie modyfikować elementów zabawki ani nie używać pocisków innych niż dostarczone z zabawką.

CZ **UPOZORNĚNÍ:** Nikdy nepřevrťte součástky a nepoužívejte jiné projektily než ty, které jsou dodávány s touto hračkou.

SK **UPOZORNENIE:** Nikdy neprevrťte súčastičky a nepoužívajte iné projektily než tie, ktoré sú dodávané s touto hračkou.

HU **PONTOS:** Az elemeket nem szabad módosítani, és a játékhoz adott lövedékek helyett sem szabad másat használni.

UA **ВАЖЛИВО:** забороняється вносити зміни до елементів або використовувати інші снаряди на відміну від тих, що поставляються з цією іграшкою.

HR **VAŽNO:** Nemojte nikad mijenjati elemente ili koristiti druge projekte osim onih koji su bili priloženi uz ovu igračku prilikom kupnje.

SR **Важно:** Немојте да модификујете елементе и не користите друге пројектиле осим оних који долазе уз ову играчку.

SL **POMBENI:** Nikoli ne spreminjajte elementov in uporabljajte le izstrleke, ki so bili priloženi tej igrački.

RO **IMPORTANT:** Nu modificați niciodată elementele și nu utilizați alte proiectile decât cele furnizate cu această jucărie.

BG **ВАЖНО:** Не вносите промените елементите и не използвайте други снаряди освен приложените към тази играчка.

LV **SVARĪGI!** Nekad nepārveidojiet rotaļlietas elementus, vienmēr izmantojiet tikai tās komplektā iekļautās lodītes.

ET **OLULINE:** Mõnuga ei ei tohi teha teha muudatusi, kasutada võib ainult kasasolevat hõltsid.

LT **DEMESIO!** Nekuoamet nekeisite elementų ir naudokite tik tuos šovinius, kurie yra pridėti prie šio žaislo.

TR **ÖNEMLİ:** Hiçbir zaman parçaların değiştirilerek yapılmayın veya bu oyuncakla eşleşenler dışında mermiler kullanmayın.



club™



FREE LEGO Magazine • GRATUIT • GRATIS LEGO Magazin

Join Today!

**Abonne-toi
dès aujourd'hui!**

Meld je nu aan!

Jetzt anmelden!



US & Canada only

1-866-534-6258 / 1-877-518-5346

(en français)



00800 5346 5555

www.LEGOclub.com

**VISIT THE WORLD'S
BIGGEST LEGO® SHOP!**

www.LEGOshop.com

www.acnielsen.aim.dk/LEGO



WIN LEGO® PRODUCTS

No purchase necessary.
Open to residents of all countries where
not prohibited.
Go to www.aim.dk for official rules and details.

WIN LEGO® PRODUCTEN

Kopen niet nodig.
Open voor alle leeftijden, en in alle landen
waar geen verbod geldt.
Ga naar www.aim.dk voor officiële regels en details.

GEWINNE LEGO® PRODUKTE

Die Teilnahme am Gewinnspiel führt zu
keinerlei Kaufverpflichtungen.
Sie können in allen nicht ausgeschlossenen
Ländern teilnehmen.
Die offiziellen Regeln und nähere Informationen
finden Sie unter www.aim.dk.

GAGNE DES PRODUITS LEGO®

Aucun achat n'est nécessaire.
Ouvert à tous les âges et aux résidents de
tous les pays, sauf en cas d'interdiction.
Rendez-vous sur www.aim.dk pour obtenir plus
de détails et le règlement officiel.

レゴ®製品を「当てよう」

購入は不要です
禁止されていない限り、あらゆる
年代およびあらゆる国の居住者の
方々にご利用いただけます。
公認規則および詳細につきましては、
www.aim.dkをご覧ください



 www.LEGO.com